



**EGLO**  
my light | my style



Außenleuchten  
**Outdoor lighting 2015**  
Luminaires extérieurs







**Dear customers, business partners and trusted EGLO friends,**

whether for balcony, garden, entrance area, carport or garage, in our outdoor lighting collection 2015 you will find your right luminaire. Depending on your taste and application area we have compiled modern, classical and functional luminaires for you.

Look forward to spending your valuable time outdoors and when the sun does not shine that long, simply switch the light on and extend your wellness time in the countryside.

Enjoy browsing our catalogue!

Ludwig Obwieser

Gründer & Eigentümer  
Owner & Founder  
Propriétaire & fondateur

**Geschätzte Kunden und Geschäftspartner, treue EGLO-Freunde,**

ob für Balkon, Garten, Eingangsbereich, Carport oder Garage, in unserer neuen Aussenleuchtsortiment 2015 finden Sie die passende Beleuchtung. Je nach Geschmack und Einsatzbereich haben wir für Sie moderne, klassische und funktionelle Leuchten zusammengestellt.

Freuen Sie sich darauf Ihre wertvolle Freizeit im Freien zu verbringen und wenn die Sonne mal nicht so lange scheint, machen Sie einfach das Licht an und verlängern Sie Ihre Wohlfühlzeit im Grünen.

Viel Spaß beim Durchblättern!

**Chers clients et partenaires commerciaux, fidèles amis d'EGLO,**

*que ce soit les luminaires pour balcon, jardin, hall d'entrée, parking ou garage, dans notre collection extérieur 2015, vous trouvez le bon éclairage. Selon vos goûts et votre domaine d'application, nous avons compilé pour vous des luminaires modernes, classiques et fonctionnelles.*

*Réjouissez-vous de dépenser de temps précieux à l'extérieur et quand le soleil ne brille pas à long, juste allumez la lumière pour prolonger votre temps à l'extérieur.*

*Nous vous souhaitons une agréable lecture!*



# INHALT CONTENTS CONTENU

## Products

	<b>Modern</b> Modern <i>Moderne</i>	006 - 059
	<b>Classic</b> Klassik <i>Classique</i>	072 - 101
	<b>Spots, Recessed &amp; Accessories</b> Spots, Einbauleuchten & Zubehör <i>Spots, luminaires encastrés &amp; accessoires</i>	102 - 113

## Concepts

	<b>Garden Living</b>	060 - 071
---	----------------------	-----------

## Appendix

	<b>Register &amp; Legend</b> Register & Legende <i>Registre &amp; Légende</i>	114 - 119
	<b>EGLO Worldwide</b> EGLO weltweit <i>EGLO au monde</i>	120 - 121



# Modern





# Overview

## Modern



BASALGO 1  
p. 10



BASALGO 2  
p. 11



FONTACINA  
p. 11



TRONO 2  
p. 13



TRONO STICK  
p. 13



TRONO 1  
p. 13



CADIZ 1  
p. 15



KONYA  
p. 15



KONYA  
p. 15



BEVERLY  
p. 15



RIGA-LED  
p. 16



RIGA 2  
p. 17



RIGA  
p. 17



RIGA  
p. 18



RIGA  
p. 19



RIGA  
p. 19



RIGA  
p. 19



ASCOLI  
p. 20



STOCK-  
HOLM 1  
p. 21



CABOS  
p. 21



HELSINKI-LED  
p. 23



HELSINKI  
p. 23



ROFFIA  
p. 24



CALGARY 1  
p. 24



CALGARY  
p. 25



PANAMA 1  
p. 26



MOUNA  
p. 28



ARIOLLA  
p. 29



NISIA  
p. 30



OHIO  
p. 30



NISIA 1  
p. 31



MORINO  
p. 33



REDONDO  
p. 32



SOJO  
p. 34



ESPARTA 1  
p. 34



FASTRO 1  
p. 35



FASTRO  
p. 35



BOSARO  
p. 35



KIBEA  
p. 35



RALORA  
p. 35



NADELA  
p. 36



NADELA  
p. 36



ESPARTA  
p. 36



PREDAZZO  
p. 36



RAVARINO  
p. 37



ARCHA  
p. 37



BENACO  
p. 37



BENACO  
p. 37



TABO-LED  
p. 38



PIAS  
p. 38



PARDELA 1  
p. 38



TABO  
p. 41



TABO 1  
p. 41



FONTELA  
p. 42



PARDELA  
p. 42



RUSTEGA  
p. 43



PIAS  
p. 43



NORIKA 1  
p. 44



MORINO  
p. 44

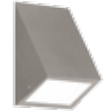

ARKTIC  
p. 44



VOLPINO  
p. 45



MORINO  
p. 45



CORFINO  
p. 45



BREGANZO  
p. 46



PARK  
p. 46



MALGERA  
p. 47



PARK 5  
p. 47



VESCAVA  
p. 47



NOCELLA  
p. 48



NAGO  
p. 48



LAVORIA  
p. 48



CITY 2  
p. 49



SEVILLA  
p. 49



CITY  
p. 50



CITY 1  
p. 50



CITY  
p. 50



CITY LED  
p. 52



ISOBA  
p. 52



DARIL  
p. 53



CERNO  
p. 53



ONJA  
p. 54



VENTO 1  
p. 55



VENTO 1  
p. 55



SIONES  
p. 56



ANOLA  
p. 56



SIONES  
p. 56



ANOLA  
p. 57



NAGO  
p. 58



MILTON  
p. 58



SEVILLA  
p. 58



CITY  
p. 58



LEPUS  
p. 58

LED

94281 BASALGO 1

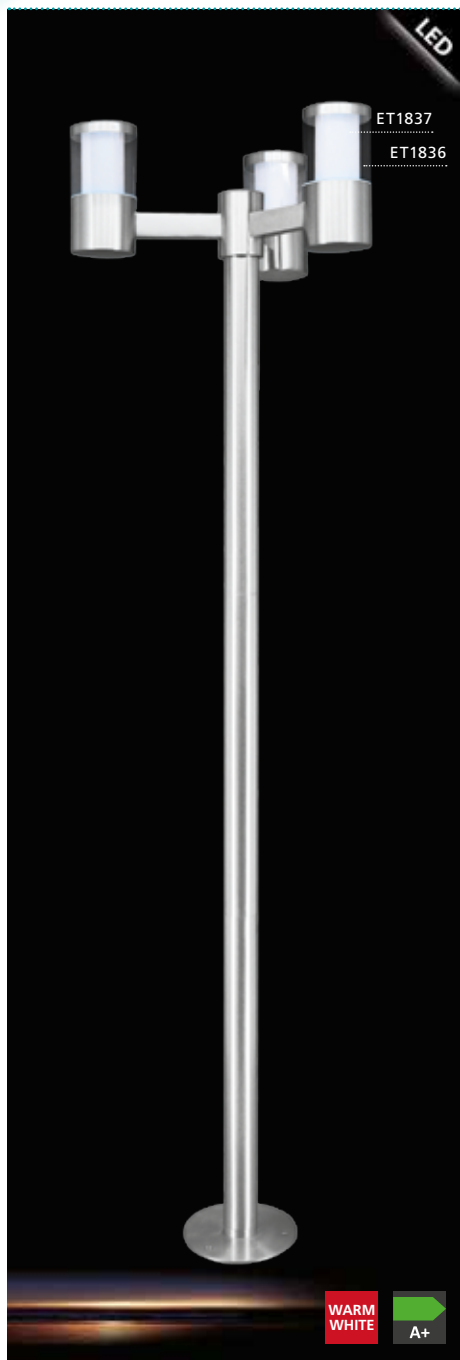

floor luminaire; stainless steel, stainless steel / plastic, clear, white  
**Stehleuchte; Edelstahl, edelstahl / Kunststoff, klar, weiss**  
*lampadaire; acier inoxydable, acier inoxydable / plastique, clair, blanc*

H 1900, Ø 490



9 002759 942816



3x 3,7W 840 lm



IP44

ET1836, ET1837



94279 BASALGO 1



floor luminaire; stainless steel, stainless steel / plastic, clear, white  
**Stehleuchte; Edelstahl, edelstahl / Kunststoff, klar, weiss**  
*lampadaire; acier inoxydable, acier inoxydable / plastique, clair, blanc*

H 1050, Ø 105



9 002759 942793



1x 3,7W 280 lm



IP44

ET1836, ET1837



94277 BASALGO 1



wall luminaire; stainless steel, stainless steel / plastic, clear, white  
**Wandleuchte; Edelstahl, edelstahl / Kunststoff, klar, weiss**  
*applique; acier inoxydable, acier inoxydable / plastique, clair, blanc*

L 105, H 180, A 210



9 002759 942779



1x 3,7W 280 lm



IP44

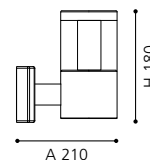

ET1836, ET1837

94278 BASALGO 1

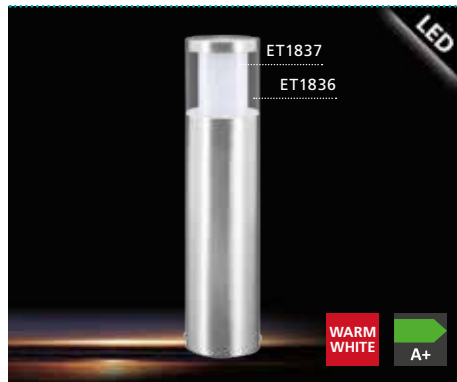

floor luminaire; stainless steel, stainless steel / plastic, clear, white  
**Stehleuchte; Edelstahl, edelstahl / Kunststoff, klar, weiss**  
*lampadaire; acier inoxydable, acier inoxydable / plastique, clair, blanc*

H 450, Ø 105



9 002759 942786



1x 3,7W 280 lm



IP44

ET1836, ET1837





93269 BASALGO



wall luminaire; stainless steel, stainless steel / plastic, clear  
**Wandleuchte; Edelstahl, edelstahl / Kunststoff, klar**  
*applique; acier inoxydable, acier inoxydable / plastique, clair*

L 100, H 210, A 150

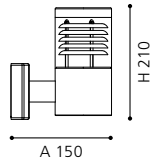

94131 FONTACINA



wall luminaire; stainless steel, stainless steel / structured glass, clear  
**Wandleuchte; Edelstahl, edelstahl / Glas mit Struktur, klar**  
*applique; acier inoxydable, acier inoxydable / verre structuré, clair*

L 75, H 230, A 110

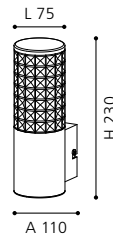

GL3199

94132 FONTACINA

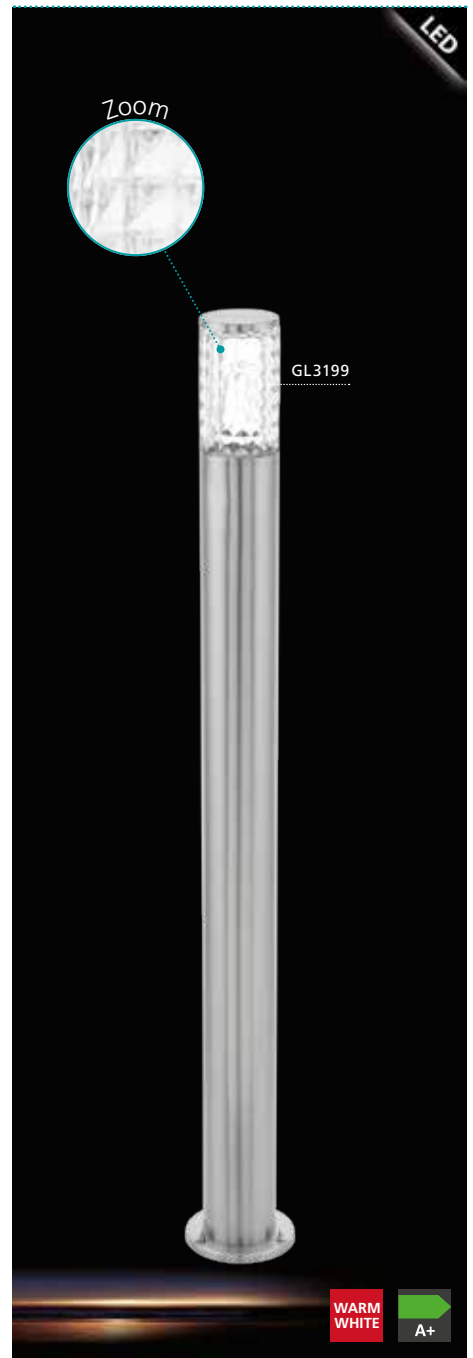

floor luminaire; stainless steel, stainless steel / structured glass, clear  
**Stehleuchte; Edelstahl, edelstahl / Glas mit Struktur, klar**  
*lampadaire; acier inoxydable, acier inoxydable / verre structuré, clair*

H 965, Ø 75

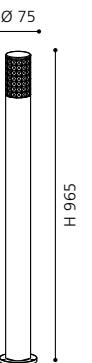
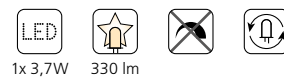

GL3199





LED

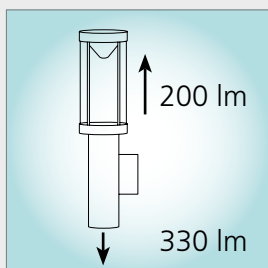

#### TRONO 1, TRONO 2, TRONO STICK

These luminaires come with lighting that is directed upwards as well as downwards.

Diese Leuchten sind sowohl mit nach oben als auch mit nach unten gerichteten Leuchten ausgestattet.

*Ces luminaires brillent non seulement vers le bas, mais aussi vers le haut.*



94125 TRONO 2

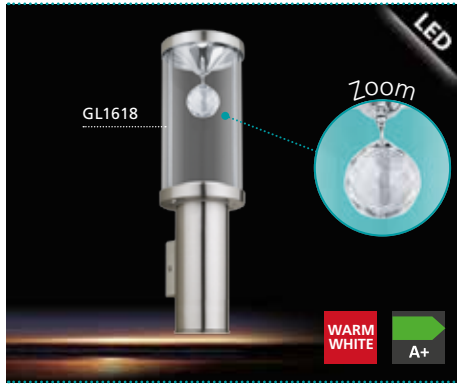

wall luminaire; stainless steel, stainless steel / glass, crystal, clear  
**Wandleuchte; Edelstahl, edelstahl / Glas, Kristall, klar**  
*applique; acier inoxydable, acier inoxydable / verre, cristal, clair*

L 105, H 350, A 115

9 002759 941253

GU10 1x 3W 200 lm 1x 3,7W

330 lm IP44

GL1618

94127 TRONO STICK

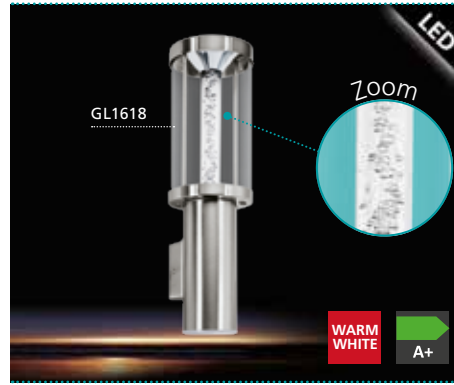

wall luminaire; stainless steel, stainless steel / glass, plastic, clear  
**Wandleuchte; Edelstahl, edelstahl / Glas, Kunststoff, klar**  
*applique; acier inoxydable, acier inoxydable / verre, plastique, clair*

L 105, H 350, A 115

9 002759 941277

GU10 1x 3W 200 lm 1x 3,7W

330 lm IP44

GL1618

94208 TRONO 1



wall luminaire; stainless steel, stainless steel / glass, clear  
**Wandleuchte; Edelstahl, edelstahl / Glas, klar**  
*applique; acier inoxydable, acier inoxydable / verre, clair*

L 105, H 350, A 115

9 002759 942083

GU10 1x 3W 200 lm 1x 3,7W

330 lm IP44

GL1618

94126 TRONO 2



wall luminaire; stainless steel, stainless steel / glass, crystal, clear  
**Wandleuchte; Edelstahl, edelstahl / Glas, Kristall, klar**  
*applique; acier inoxydable, acier inoxydable / verre, cristal, clair*

L 105, H 410, A 175

9 002759 941260

GU10 1x 3W 200 lm 1x 3,7W

330 lm IP44

GL1618

94128 TRONO STICK



wall luminaire; stainless steel, stainless steel / glass, plastic, clear  
**Wandleuchte; Edelstahl, edelstahl / Glas, Kunststoff, klar**  
*applique; acier inoxydable, acier inoxydable / verre, plastique, clair*

L 105, H 410, A 175

9 002759 941284

GU10 1x 3W 200 lm 1x 3,7W

330 lm IP44

GL1618

94209 TRONO 1

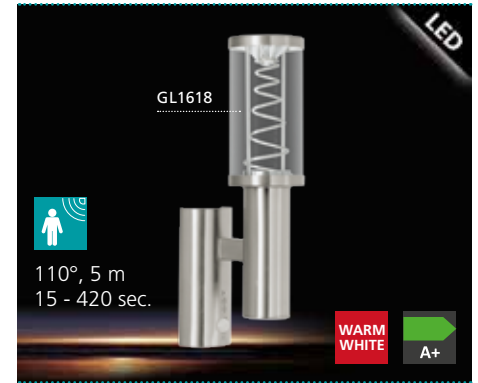

wall luminaire; stainless steel, stainless steel / glass, clear  
**Wandleuchte; Edelstahl, edelstahl / Glas, klar**  
*applique; acier inoxydable, acier inoxydable / verre, clair*

L 105, H 410, A 175

9 002759 942090

GU10 1x 3W 200 lm 1x 3,7W

330 lm IP44

GL1618

92336 CADIZ 1



floor luminaire; stainless steel, stainless steel / plastic, white  
Stehleuchte; Edelstahl, edelstahl / Kunststoff, weiss  
lampadaire; acier inoxydable, acier inoxydable / plastique,  
blanc

H 1100, Ø 90, Base: Ø 115



E27



1x 15W



IP44

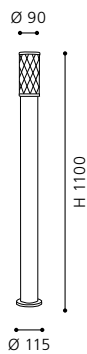

92335 CADIZ 1



wall luminaire; stainless steel, stainless steel / plastic, white  
**Wandleuchte; Edelstahl, edelstahl / Kunststoff, weiss**  
*applique; acier inoxydable, acier inoxydable / plastique, blanc*

H 390, Ø 90, A 165

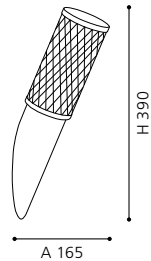

86385 KONYA



wall luminaire; stainless steel, stainless steel / satinated glass, white  
**Wandleuchte; Edelstahl, edelstahl / Glas satiniert, weiss**  
*applique; acier inoxydable, acier inoxydable / verre satiné, blanc*

L 80, H 215, A 120

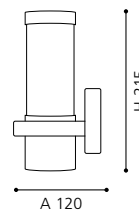

GL1073

86248 KONYA



pedestal luminaire; stainless steel, stainless steel / satinated glass, white  
**Sockelleuchte; Edelstahl, edelstahl / Glas satiniert, weiss**  
*borne; acier inoxydable, acier inoxydable / verre satiné, blanc*

H 350, Base: Ø 90

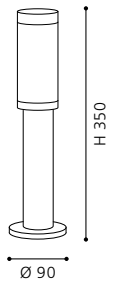

GL1073

86541 BEVERLY



wall luminaire; stainless steel, stainless steel, silver / satinated glass, white  
**Wandleuchte; Edelstahl, edelstahl, silber / Glas satiniert, weiss**  
*applique; acier inoxydable, acier inoxydable, argent / verre satiné, blanc*

L 200, H 350, A 135

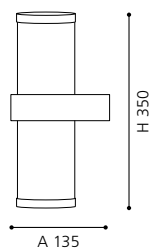

GL1079





## 92738 RIGA-LED

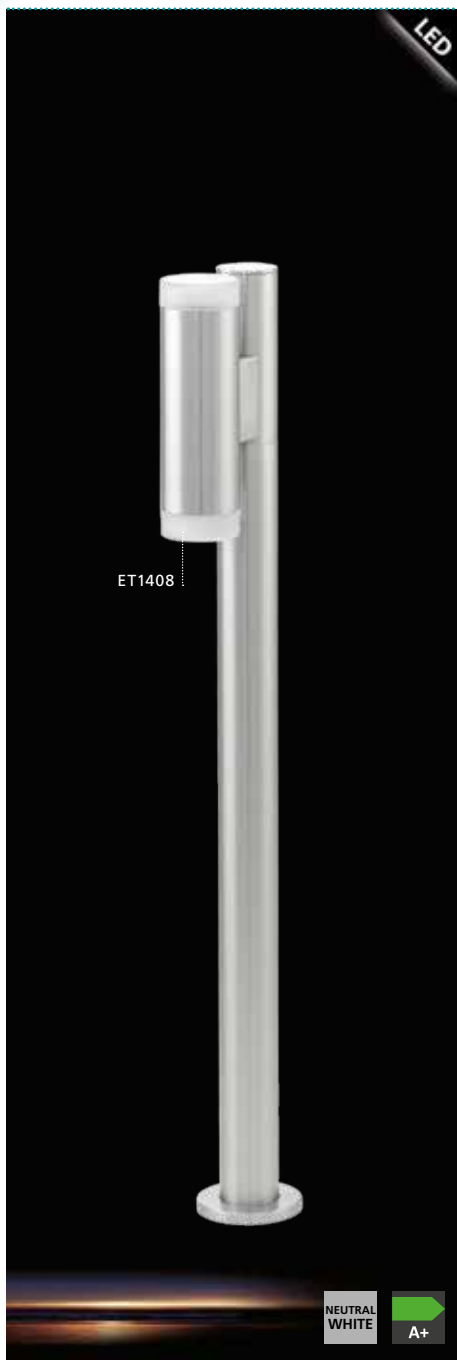

floor luminaire; stainless steel, stainless steel / plastic, satined  
Stehleuchte; Edelstahl, edelstahl / Kunststoff, satiniert  
lampadaire; acier inoxydable, acier inoxydable / plastique, satiné

L 130, B 65, H 805, Base: Ø 90



9 002759 927387

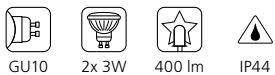

GU10 2x 3W 400 lm IP44

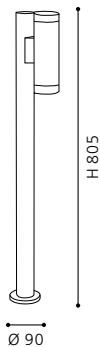

H 805

Ø 90

ET1408

## 92735 RIGA-LED



wall luminaire; stainless steel, stainless steel / plastic, satined  
Wandleuchte; Edelstahl, edelstahl / Kunststoff, satiniert  
applique; acier inoxydable, acier inoxydable / plastique, satiné

L 65, H 160, A 95



9 002759 927356



GU10 1x 3W 200 lm IP44



IP44

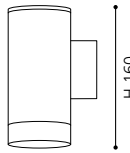

H 160

A 95

ET1408

## 92736 RIGA-LED



wall luminaire; stainless steel, stainless steel / plastic, satined  
Wandleuchte; Edelstahl, edelstahl / Kunststoff, satiniert  
applique; acier inoxydable, acier inoxydable / plastique, satiné

L 65, H 205, A 95



9 002759 927363

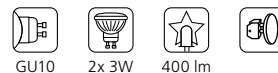

GU10 2x 3W 400 lm IP44



IP44

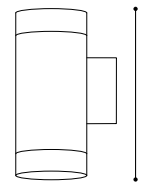

H 205

A 95

ET1408

## 92737 RIGA-LED



floor luminaire; stainless steel, stainless steel / plastic, satined  
Stehleuchte; Edelstahl, edelstahl / Kunststoff, satiniert  
lampadaire; acier inoxydable, acier inoxydable / plastique, satiné

L 130, B 65, H 355, Base: Ø 90



9 002759 927370

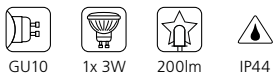

GU10 1x 3W 200 lm IP44



IP44

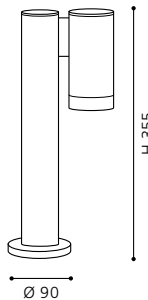

H 355

Ø 90

ET1408



94108 RIGA 2

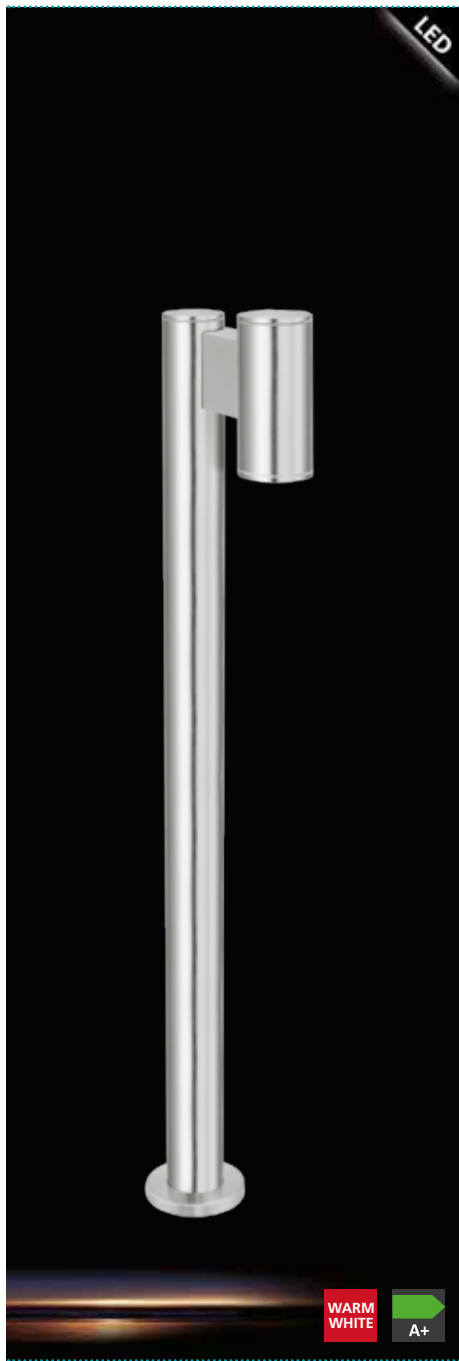

floor luminaire; stainless steel, stainless steel  
**Stehleuchte; Edelstahl, edelstahl**  
*lampadaire; acier inoxydable, acier inoxydable*

B 130, H 800, Base: Ø 90



9 002759 941086

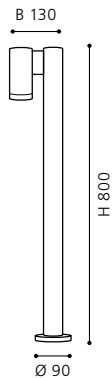

94106 RIGA



wall luminaire; stainless steel, stainless steel  
**Wandleuchte; Edelstahl, edelstahl**  
*applique; acier inoxydable, acier inoxydable*

L 65, H 150, A 95



9 002759 941062

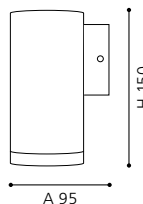

94107 RIGA

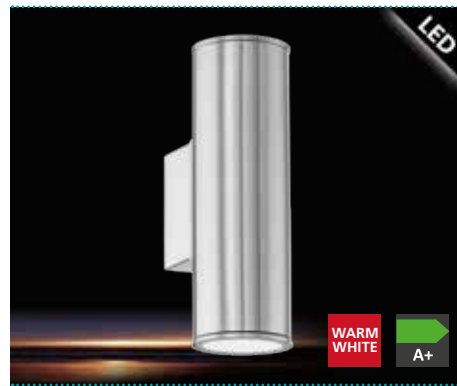

wall luminaire; stainless steel, stainless steel  
**Wandleuchte; Edelstahl, edelstahl**  
*applique; acier inoxydable, acier inoxydable*

L 65, H 200, A 95



9 002759 941079

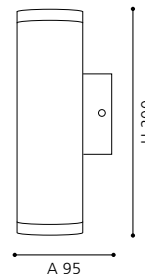

94098 RIGA 2



wall luminaire; stainless steel, stainless steel  
**Wandleuchte; Edelstahl, edelstahl**  
*applique; acier inoxydable, acier inoxydable*

L 100, H 340, A 95



9 002759 940980

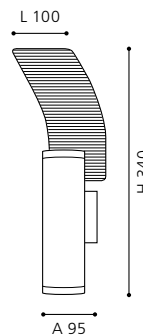

LED



94105, 94103, 94101,  
84002

These luminaires come with lighting that is directed upwards as well as downwards.

Diese Leuchten sind sowohl mit nach oben als auch mit nach unten gerichteten Leuchten ausgestattet.

*Ces luminaires brillent non seulement vers le bas, mais aussi vers le haut.*

94105 RIGA



wall luminaire; galvanized steel, antique brown  
Wandleuchte; Stahl verzinkt, antik-braun  
applique; acier galvanisé, marron antique

L 65, H 200, A 95



9 002759 941055



GU10



2x 3W



IP44



400 lm

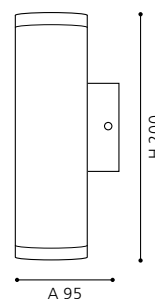

94104 RIGA



wall luminaire; galvanized steel, antique brown  
Wandleuchte; Stahl verzinkt, antik-braun  
applique; acier galvanisé, marron antique

L 65, H 150, A 95



9 002759 941048



GU10



1x 3W



IP44



200 lm

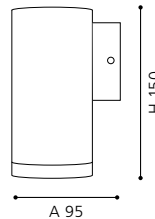



94103 RIGA



wall luminaire; galvanized steel, anthracite  
Wandleuchte; Stahl verzinkt, anthrazit  
applique; acier galvanisé, anthracite

L 65, H 200, A 95

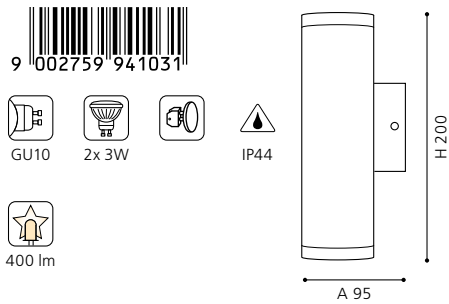

94101 RIGA



wall luminaire; galvanized steel, white  
Wandleuchte; Stahl verzinkt, weiss  
applique; acier galvanisé, blanc

L 65, H 200, A 95

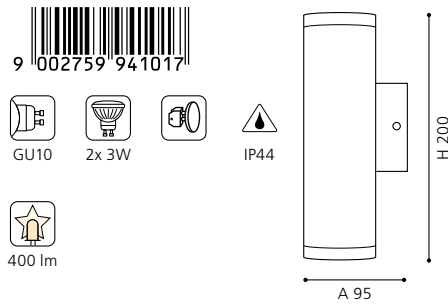

84002 RIGA



wall luminaire; stainless steel, stainless steel  
Wandleuchte; Edelstahl, edelstahl  
applique; acier inoxydable, acier inoxydable

L 65, H 200, A 95

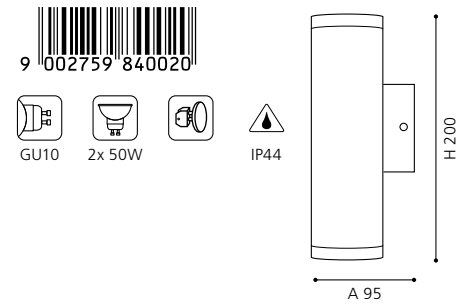

GL3091

94102 RIGA



wall luminaire; galvanized steel, anthracite  
Wandleuchte; Stahl verzinkt, anthrazit  
applique; acier galvanisé, anthracite

L 65, H 150, A 95

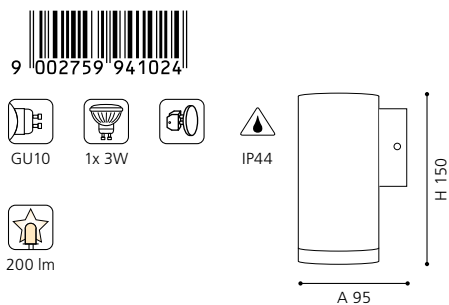

94099 RIGA



wall luminaire; galvanized steel, white  
Wandleuchte; Stahl verzinkt, weiss  
applique; acier galvanisé, blanc

L 65, H 150, A 95

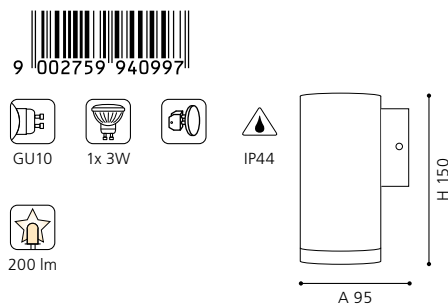

83998 RIGA



wall luminaire; stainless steel, stainless steel  
Wandleuchte; Edelstahl, edelstahl  
applique; acier inoxydable, acier inoxydable

L 65, H 150, A 95

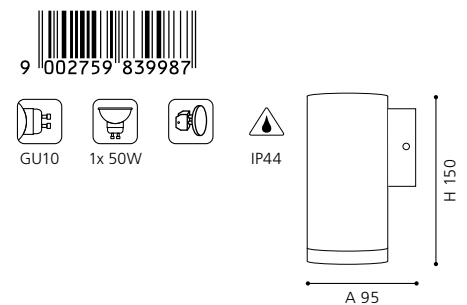

GL3091

90119 ASCOLI



wall luminaire; stainless steel, stainless steel / glass, clear  
 Wandleuchte; Edelstahl, edelstahl / Glas, klar  
 applique; acier inoxydable, acier inoxydable / verre, clair



90121 ASCOLI



wall luminaire; stainless steel, stainless steel / glass, clear  
 Wandleuchte; Edelstahl, edelstahl / Glas, klar  
 applique; acier inoxydable, acier inoxydable / verre, clair



L 125, H 220, A 160



9 002759 901196

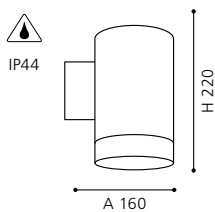

L 125, H 325, A 160



9 002759 901219

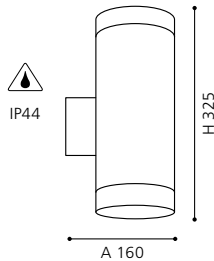

90121, 93271

These luminaires come with lighting that is directed upwards as well as downwards.

Diese Leuchten sind sowohl mit nach oben als auch mit nach unten gerichteten Leuchten ausgestattet.

*Ces luminaires brillent non seulement vers le bas, mais aussi vers le haut.*



LED



93268 STOCKHOLM 1



wall luminaire; stainless steel, stainless steel / glass, clear  
Wandleuchte; Edelstahl, edelstahl / Glas, klar  
applique; acier inoxydable, acier inoxydable / verre, clair

Ø 65



9 002759 932688



GU10



1x 5W



IP44



400 lm

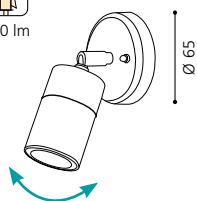

93271 CABOS



wall luminaire; stainless steel, stainless steel / glass, satined  
Wandleuchte; Edelstahl, edelstahl / Glas, satiniert  
applique; acier inoxydable, acier inoxydable / verre, satiné

L 75, H 210, A 90



9 002759 932718



LED



2x 2,5W



360 lm



IP44

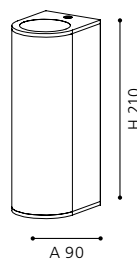

GL3025

LED

93331 HELSINKI-LED

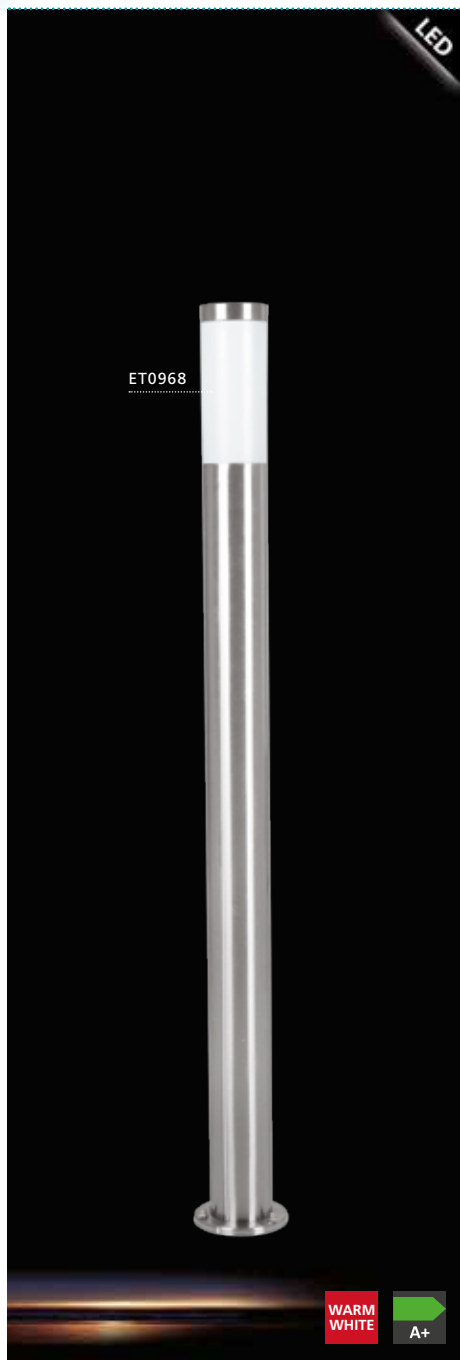

floor luminaire; stainless steel, stainless steel / plastic, white  
 Stehleuchte; Edelstahl, edelstahl / Kunststoff, weiss  
 lampadaire; acier inoxydable, acier inoxydable / plastique, blanc

83281 HELSINKI

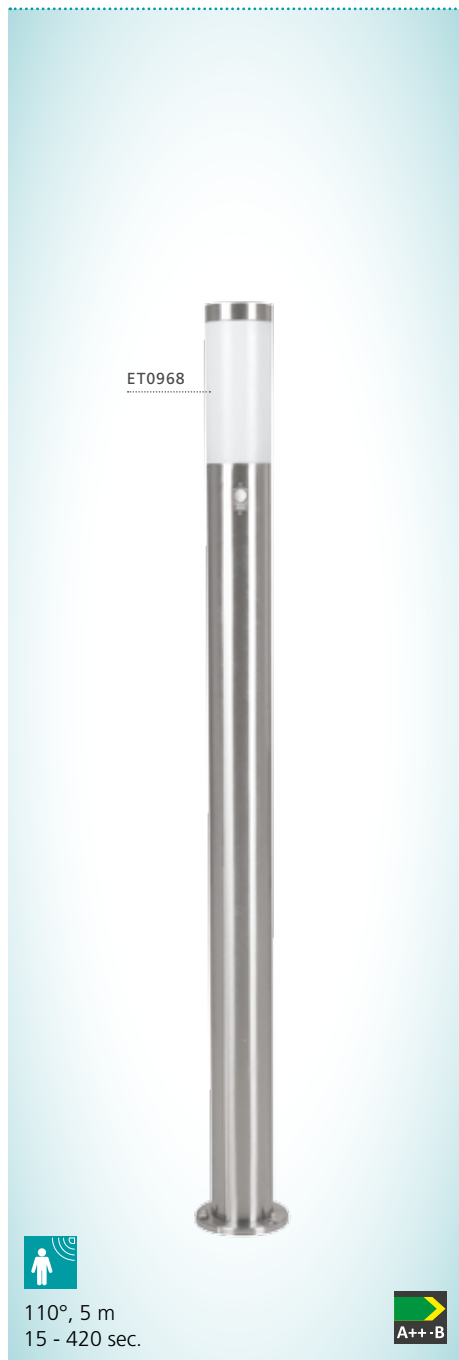

floor luminaire; stainless steel, stainless steel / plastic, white  
 Stehleuchte; Edelstahl, edelstahl / Kunststoff, weiss  
 lampadaire; acier inoxydable, acier inoxydable / plastique, blanc

81752 HELSINKI

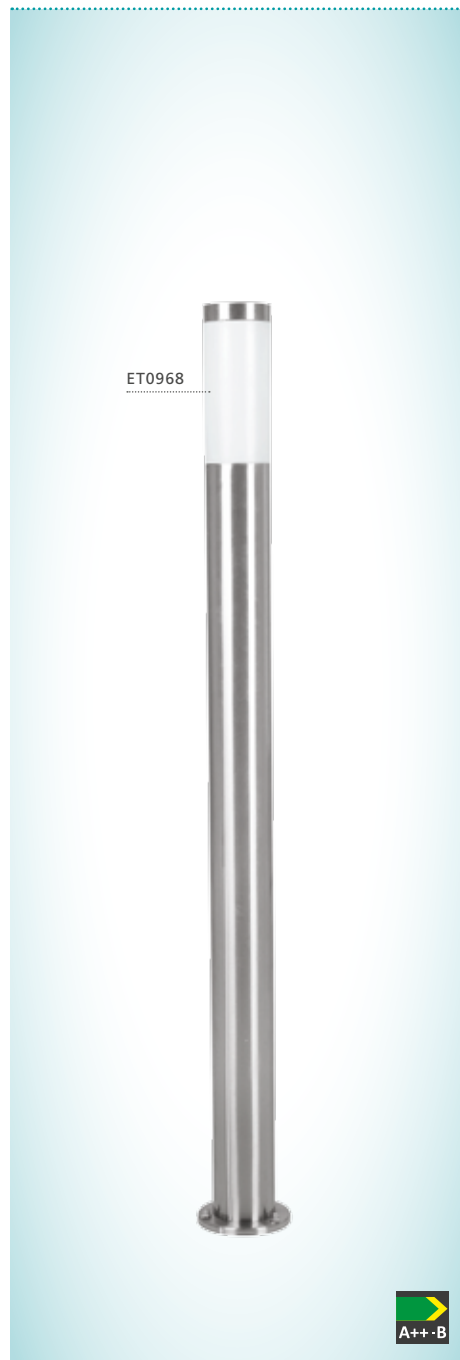

floor luminaire; stainless steel, stainless steel / plastic, white  
 Stehleuchte; Edelstahl, edelstahl / Kunststoff, weiss  
 lampadaire; acier inoxydable, acier inoxydable / plastique, blanc

H 1100, Ø 75, Base: Ø 115



9 002759 933319



ET0968

H 1100, Ø 75, Base: Ø 115



9 002759 832810

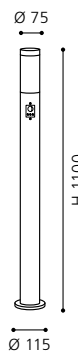

ET0968

H 1100, Ø 75, Base: Ø 115



9 002759 817527

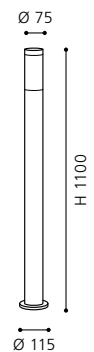
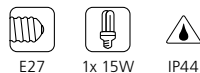

ET0968

93329 HELSINKI-LED



floor luminaire; stainless steel, stainless steel / plastic, white  
**Stehleuchte; Edelstahl, edelstahl / Kunststoff, weiss**  
*lampadaire; acier inoxydable, acier inoxydable / plastique, blanc*

H 450, Ø 75, Base: Ø 115

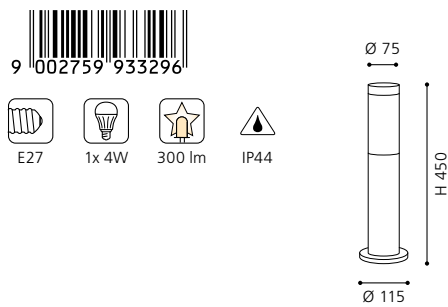

ET0968

83279 HELSINKI



floor luminaire; stainless steel, stainless steel / plastic, white  
**Stehleuchte; Edelstahl, edelstahl / Kunststoff, weiss**  
*lampadaire; acier inoxydable, acier inoxydable / plastique, blanc*

H 450, Ø 75, Base: Ø 115

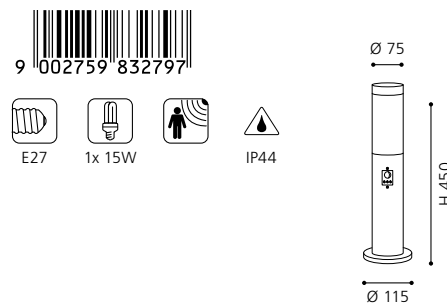

ET0968

81751 HELSINKI



floor luminaire; stainless steel, stainless steel / plastic, white  
**Stehleuchte; Edelstahl, edelstahl / Kunststoff, weiss**  
*lampadaire; acier inoxydable, acier inoxydable / plastique, blanc*

H 450, Ø 75, Base: Ø 115

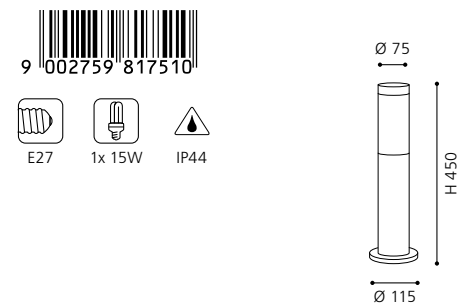

ET0968

93328 HELSINKI-LED



wall luminaire; stainless steel, stainless steel / plastic, white  
**Wandleuchte; Edelstahl, edelstahl / Kunststoff, weiss**  
*applique; acier inoxydable, acier inoxydable / plastique, blanc*

H 390, Ø 75, A 165

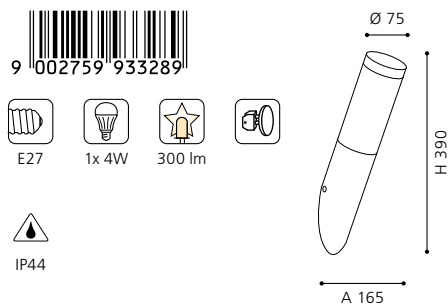

ET0968

83278 HELSINKI



wall luminaire; stainless steel, stainless steel / plastic, white  
**Wandleuchte; Edelstahl, edelstahl / Kunststoff, weiss**  
*applique; acier inoxydable, acier inoxydable / plastique, blanc*

H 425, Ø 75, A 165

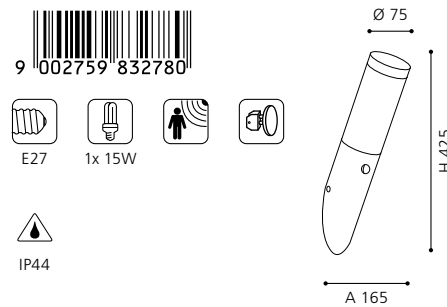

ET0968

81753 HELSINKI



wall luminaire; stainless steel, stainless steel / plastic, white  
**Wandleuchte; Edelstahl, edelstahl / Kunststoff, weiss**  
*applique; acier inoxydable, acier inoxydable / plastique, blanc*

H 390, Ø 75, A 165

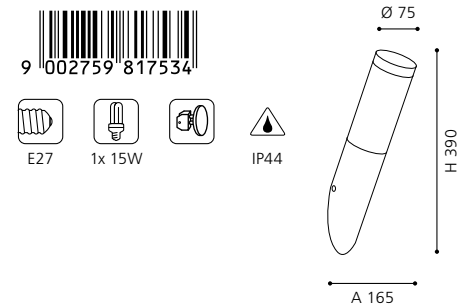

ET0968



## 94088 ROFFIA

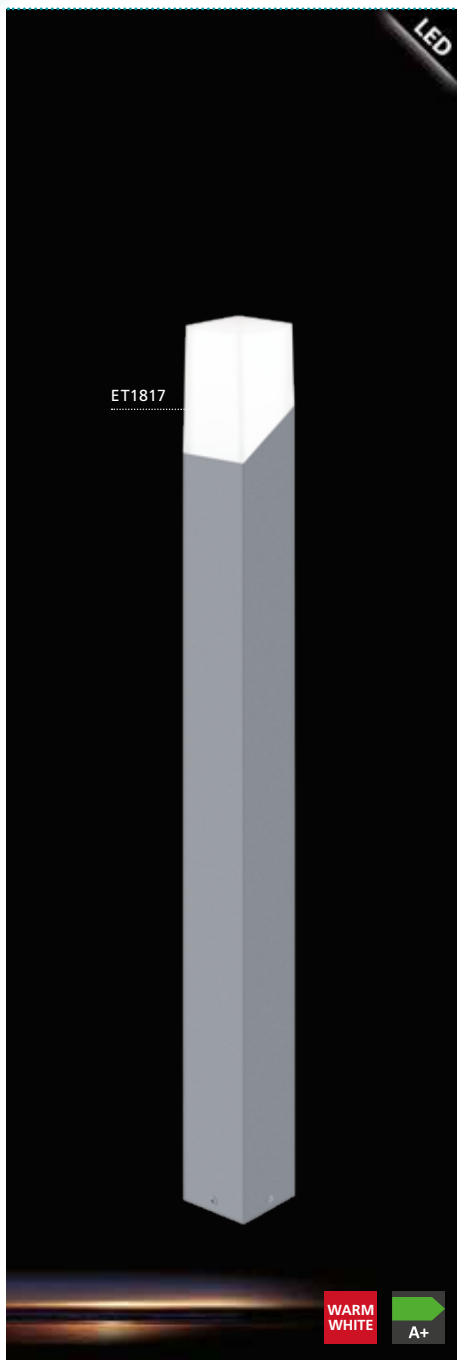

floor luminaire; aluminium, silver / plastic, white  
 Stehleuchte; Alu, silber / Kunststoff, weiss  
 lampadaire; aluminium, argent / plastique, blanc

L 90, B 90, H 1000



9 002759 940881



1x 3,7W 320 lm



IP44

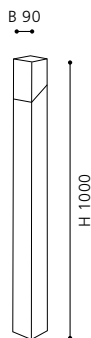

ET1817

## 94087 ROFFIA



wall luminaire; aluminium, silver / plastic, white  
 Wandleuchte; Alu, silber / Kunststoff, weiss  
 applique; aluminium, argent / plastique, blanc

L 90, H 210, A 120



9 002759 940874



1x 3,7W 320 lm



IP44

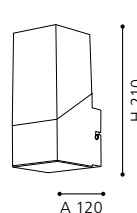

ET1817

## 94114 CALGARY 1



wall luminaire; stainless steel, stainless steel / plastic, white  
 Wandleuchte; Edelstahl, edelstahl / Kunststoff, weiss  
 applique; acier inoxydable, acier inoxydable / plastique, blanc

L 200, H 200, A 95



9 002759 941147



1x 3,7W 320 lm



IP44

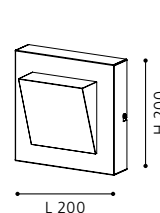

ET1811

## 94118 ROFFIA



wall luminaire; aluminium, silver / plastic, white  
 Wandleuchte; Alu, silber / Kunststoff, weiss  
 applique; aluminium, argent / plastique, blanc

L 90, H 340, A 120



9 002759 941185



2x 3,7W 640 lm



IP44

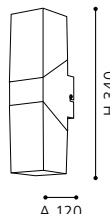

ET1810

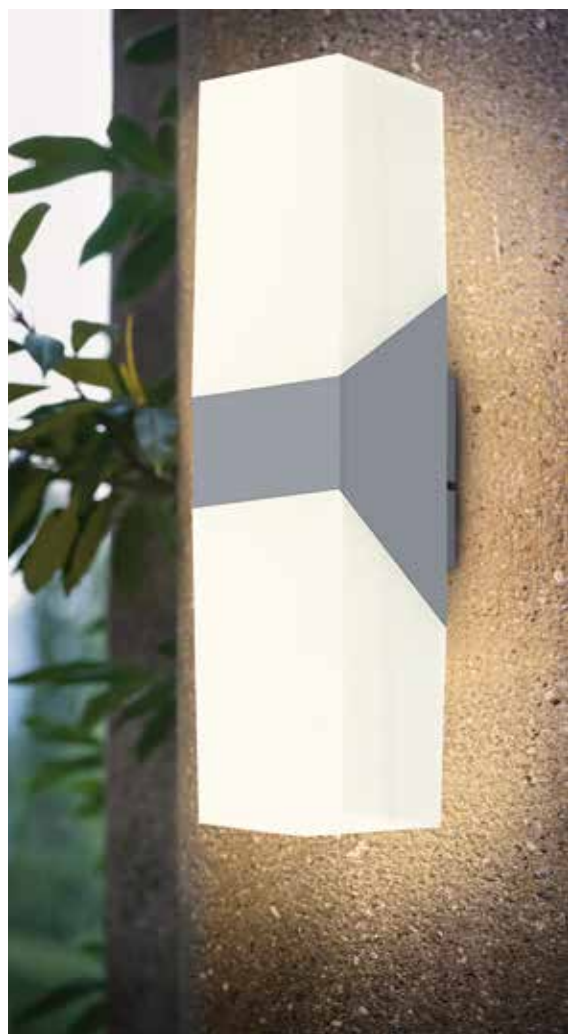

86389 CALGARY



floor luminaire; stainless steel, stainless steel / opal glass, white  
**Stehleuchte; Edelstahl, edelstahl / Glas opal-matt, weiss**  
*lampadaire; acier inoxydable, acier inoxydable / verre opale, blanc*

L 100, B 100, H 1100, Base: B 90, T 90



9 002759 863890



GL1060

86388 CALGARY



floor luminaire; stainless steel, stainless steel / opal glass, white  
**Stehleuchte; Edelstahl, edelstahl / Glas opal-matt, weiss**  
*lampadaire; acier inoxydable, acier inoxydable / verre opale, blanc*

L 100, B 100, H 435, Base: B 90, T 90



9 002759 863883

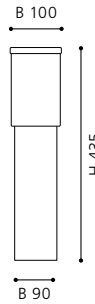

GL1060

86387 CALGARY



wall luminaire; stainless steel, stainless steel / opal glass, white  
**Wandleuchte; Edelstahl, edelstahl / Glas opal-matt, weiss**  
*applique; acier inoxydable, acier inoxydable / verre opale, blanc*

L 100, H 270, A 120, Base: B 90, T 90



9 002759 863876

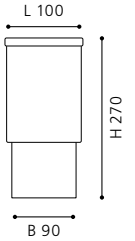

GL1060



93523 PANAMA 1

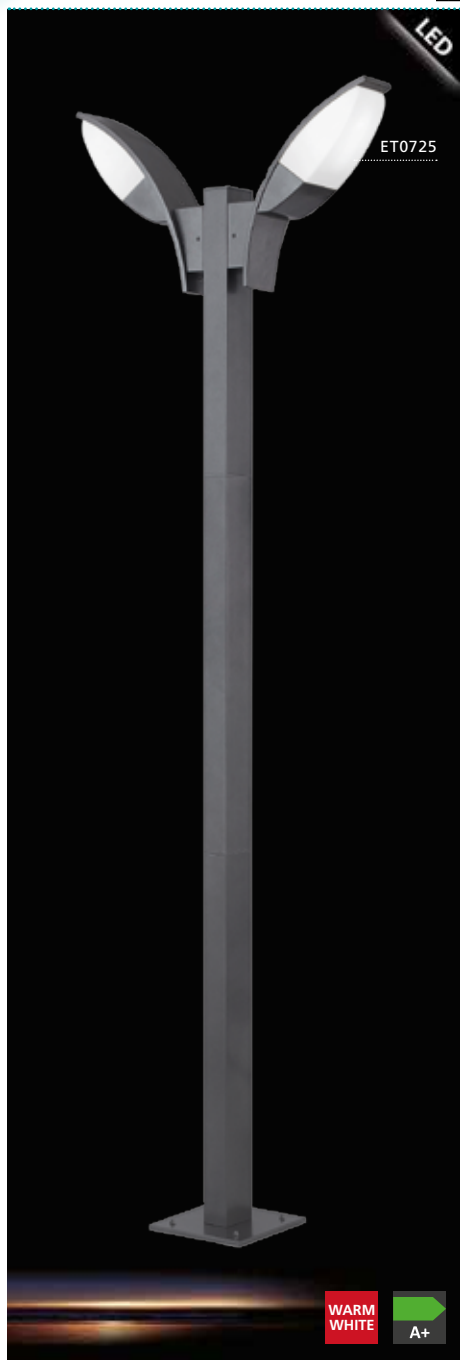

floor luminaire; cast aluminium, anthracite / plastic, white  
Stehleuchte; Aluguss, anthrazit / Kunststoff, weiss  
lampadaire; aluminium moulé, anthracite / plastique, blanc

93522 PANAMA 1

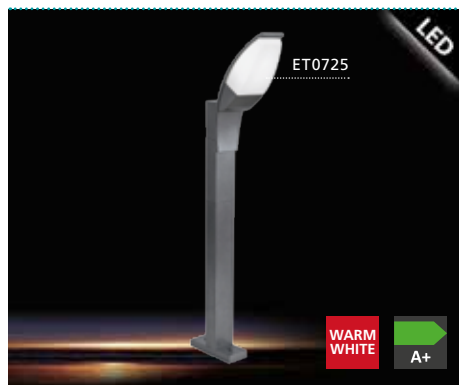

floor luminaire; cast aluminium, anthracite / plastic, white  
Stehleuchte; Aluguss, anthrazit / Kunststoff, weiss  
lampadaire; aluminium moulé, anthracite / plastique, blanc

L 110, H 1050, Base: B 205, T 75



9 002759 935221

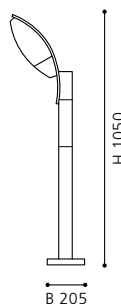

93519 PANAMA 1



wall luminaire; cast aluminium, anthracite / plastic, white  
Wandleuchte; Aluguss, anthrazit / Kunststoff, weiss  
applique; aluminium moulé, anthracite / plastique, blanc

L 110, H 345, A 285



9 002759 935191

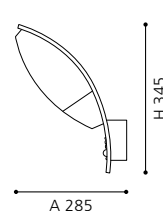

ET0725

ET0725

93521 PANAMA 1



pedestal luminaire; cast aluminium, anthracite / plastic, white  
Sockelleuchte; Aluguss, anthrazit / Kunststoff, weiss  
borne; aluminium moulé, anthracite / plastique, blanc

L 110, H 500, Base: B 205, T 75



9 002759 935214

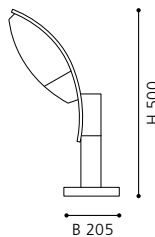

93518 PANAMA 1



wall luminaire; cast aluminium, anthracite / plastic, white  
Wandleuchte; Aluguss, anthrazit / Kunststoff, weiss  
applique; aluminium moulé, anthracite / plastique, blanc

L 110, H 345, A 285



9 002759 935184

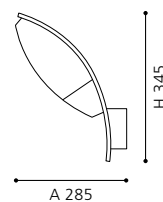

L 630, B 110, H 2000, Base: B 200, T 200



9 002759 935238

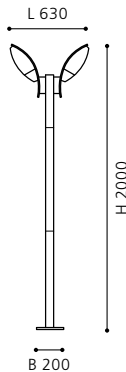

ET0725

ET0725

ET0725



LED



30183 MOUNA



floor luminaire; stainless steel, stainless steel / glass, clear  
 Stehleuchte; Edelstahl, edelstahl / Glas, klar  
 lampadaire; acier inoxydable, acier inoxydable / verre, clair

H 950, Ø 205, Base: Ø 150



9 002759 301835

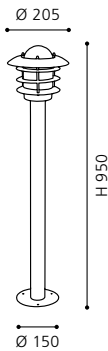

GL2939

30182 MOUNA



floor luminaire; stainless steel, stainless steel / glass, clear  
 Stehleuchte; Edelstahl, edelstahl / Glas, klar  
 lampadaire; acier inoxydable, acier inoxydable / verre, clair

H 400, Ø 205, Base: Ø 150



9 002759 301828

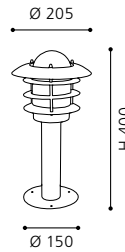

GL2939

30181 MOUNA

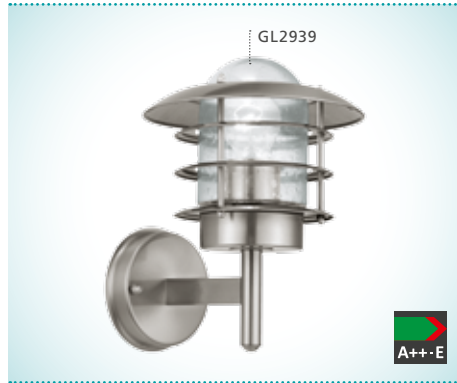

wall luminaire; stainless steel, stainless steel / glass, clear  
 Wandleuchte; Edelstahl, edelstahl / Glas, klar  
 applique; acier inoxydable, acier inoxydable / verre, clair

H 260, Ø 205, A 240



9 002759 301811

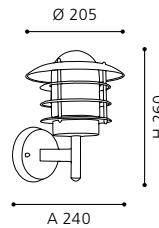

GL2939



94123 ARIOLLA

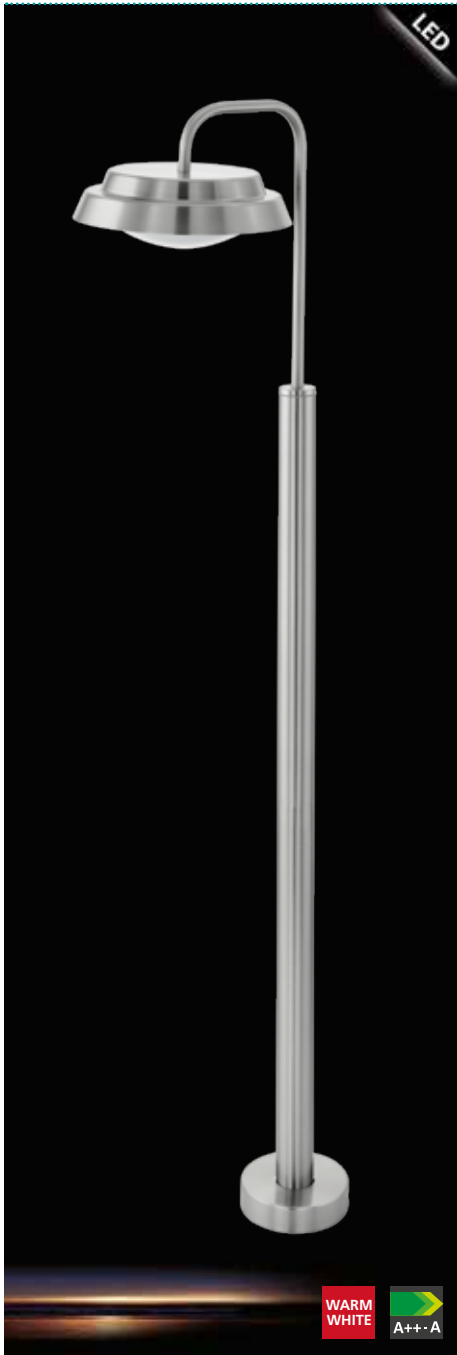

floor luminaire; stainless steel, stainless steel / plastic, white  
**Stehleuchte; Edelstahl, edelstahl / Kunststoff, weiss**  
*lampadaire; acier inoxydable, acier inoxydable / plastique, blanc*

H 1120, Ø 215



9 002759 941239



3x 2,5W 540 lm



IP44

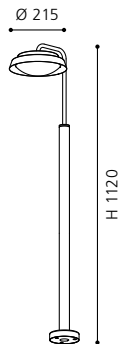

94122 ARIOLLA



wall luminaire; stainless steel, stainless steel / plastic, white  
**Wandleuchte; Edelstahl, edelstahl / Kunststoff, weiss**  
*applique; acier inoxydable, acier inoxydable / plastique, blanc*

L 215, H 275, A 280



9 002759 941222



3x 2,5W 540 lm



IP44

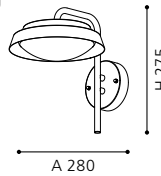



30207 NISIA



floor luminaire; stainless steel, stainless steel / satinated glass, white  
**Stehleuchte; Edelstahl, edelstahl / Glas satiniert, weiss**  
*lampadaire; acier inoxydable, acier inoxydable / verre satiné, blanc*

H 1000, Ø 200

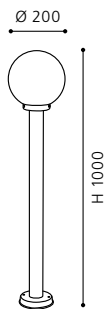

GL2852

27126 NISIA



90°, 8 m  
 5 - 240 sec.  
 wall luminaire; stainless steel, stainless steel / glass, white  
**Wandleuchte; Edelstahl, edelstahl / Glas, weiss**  
*applique; acier inoxydable, acier inoxydable / verre, blanc*

H 343, Ø 200

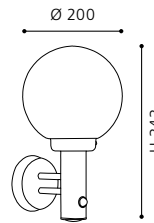

GL2852

30205 NISIA



wall luminaire; stainless steel, stainless steel / satinated glass, white  
**Wandleuchte; Edelstahl, edelstahl / Glas satiniert, weiss**  
*applique; acier inoxydable, acier inoxydable / verre satiné, blanc*

L 200, H 360, A 240

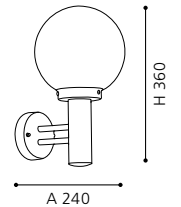
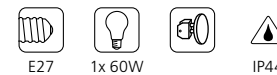

GL2852

30206 NISIA



floor luminaire; stainless steel, stainless steel / satinated glass, white  
**Stehleuchte; Edelstahl, edelstahl / Glas satiniert, weiss**  
*lampadaire; acier inoxydable, acier inoxydable / verre satiné, blanc*

H 500, Ø 200, Base: Ø 130

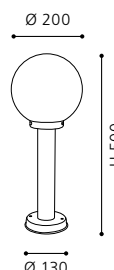

GL2852

89314 OHIO



wall luminaire; cast aluminium, stainless steel / opal glass, white  
**Wandleuchte; Aluguss, edelstahl / Glas opal-matt, weiss**  
*applique; aluminium moulé, acier inoxydable / verre opale, blanc*

L 190, H 215, A 235

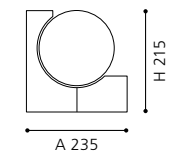
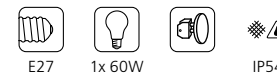

GL-805

93366 NISIA 1



wall luminaire; stainless steel, stainless steel / glass with wires, clear, aluminium  
**Wandleuchte; Edelstahl, edelstahl / Glas mit Draht, klar, alu**  
*applique; acier inoxydable, acier inoxydable / verre avec fil, clair, aluminium*

H 360, Ø 200, A 240

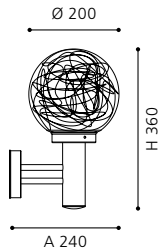

GL2968

93553 NISIA 1



floor luminaire; stainless steel, stainless steel / glass with wires, clear, aluminium  
**Stehleuchte; Edelstahl, edelstahl / Glas mit Draht, klar, alu**  
*lampadaire; acier inoxydable, acier inoxydable / verre avec fil, clair, aluminium*

H 500, Ø 200, Base: Ø 130

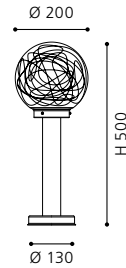

GL2968

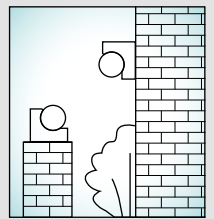

**OHIO**

This luminaire is suitable for both wall and floor placement.

**Diese Leuchte eignet sich sowohl zur Wand- als auch zur Bodenplatzierung.**

*Ce luminaire convient à la fixation au sol ou au mur.*

## 93319 MORINO



wall luminaire; cast aluminium, anthracite  
Wandleuchte; Aluguss, anthrazit  
applique; aluminium moulé, anthracite

L 140, H 180, A 105



9 002759 933197



2x 2,5W 360 lm



IP44

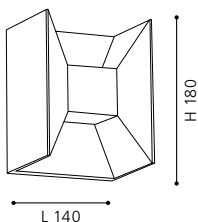

## 93368 REDONDO

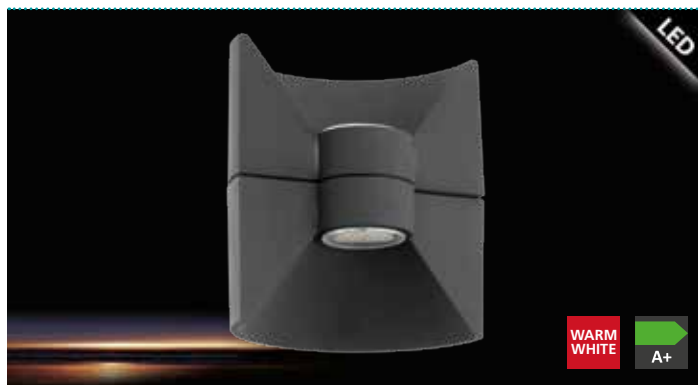

wall luminaire; cast aluminium, anthracite  
Wandleuchte; Aluguss, anthrazit  
applique; aluminium moulé, anthracite

L 160, H 175, A 125



9 002759 933685



2x 2,5W 360 lm



IP44

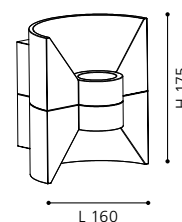



LED



93318 MORINO

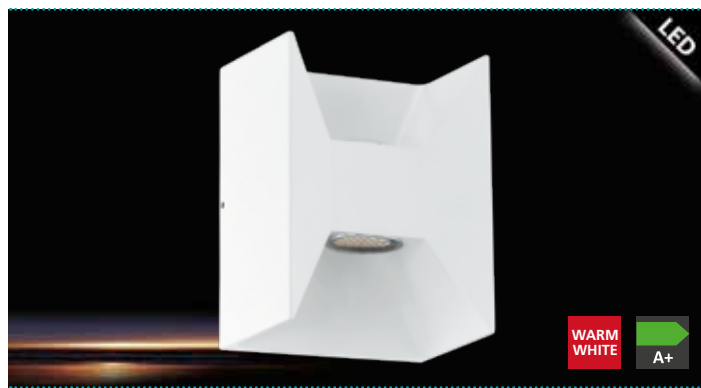

wall luminaire; cast aluminium, white  
Wandleuchte; Aluguss, weiss  
applique; aluminium moulé, blanc

L 140, H 180, A 105



2x 2,5W 360 lm



IP44

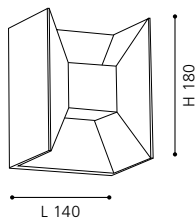

93367 REDONDO

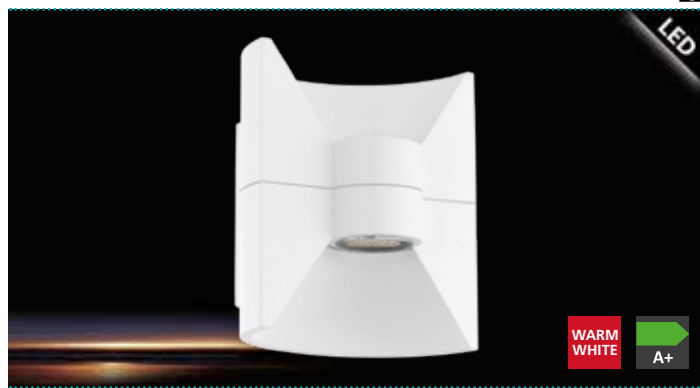

wall luminaire; cast aluminium, white  
Wandleuchte; Aluguss, weiss  
applique; aluminium moulé, blanc

L 160, H 175, A 125



2x 2,5W 360 lm



IP44

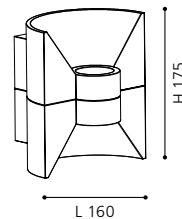

LED



93256 SOJO



wall luminaire; galvanized steel, white  
Wandleuchte; Stahl verzinkt, weiss  
applique; acier galvanisé, blanc

L 180, H 265, A 135



2x 2,5W



360 lm



H 265

L 180



IP44

93327 ESPARTA 1



wall luminaire; galvanized steel, white  
Wandleuchte; Stahl verzinkt, weiss  
applique; acier galvanisé, blanc

L 220, H 160, A 95



2x 2,5W



360 lm



IP44

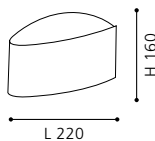

H 160

L 220





93999 FASTRO 1



wall luminaire; stainless steel, stainless-steel, white  
Wandleuchte; Edelstahl, edelstahl, weiss  
applique; acier inoxydable, stainless-steel, white

L 160, H 220, A 90

9 002759 939991

LED 2x 2,5W 360 lm

IP44

93998 FASTRO



wall luminaire; stainless steel, stainless-steel, white  
Wandleuchte; Edelstahl, edelstahl, weiss  
applique; acier inoxydable, stainless-steel, white

L 215, H 220, A 105

9 002759 939984

LED 2x 2,5W 360 lm

IP44

93991 BOSARO



wall luminaire; galvanized steel, white  
Wandleuchte; Stahl verzinkt, weiss  
applique; acier galvanisé, blanc

L 170, H 270, A 105

9 002759 939915

LED 2x 2,5W 360 lm

IP44

93253 KIBEA



wall luminaire; galvanized steel, white  
Wandleuchte; Stahl verzinkt, weiss  
applique; acier galvanisé, blanc

L 150, H 260, A 75

9 002759 932534

LED 2x 2,5W 360 lm

IP44

93254 KIBEA



wall luminaire; galvanized steel, white, anthracite  
Wandleuchte; Stahl verzinkt, weiss, anthrazit  
applique; acier galvanisé, blanc, anthracite

L 150, H 260, A 75

9 002759 932541

LED 2x 2,5W 360 lm

IP44

94086 RALORA



wall luminaire; stainless steel, stainless steel / plastic, white  
Wandleuchte; Edelstahl, edelstahl / Kunststoff, weiss  
applique; acier inoxydable, acier inoxydable / plastique, blanc

L 140, H 240, A 70

9 002759 940867

LED 3x 2,5W 540 lm

IP44

## 93437 NADELA



wall luminaire; stainless steel, stainless steel  
Wandleuchte; Edelstahl, edelstahl  
applique; acier inoxydable, acier inoxydable

L 225, H 125, A 90



9 002759 934378



2x 2,5W 360 lm



IP44

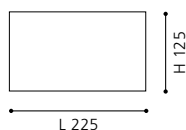

L 225

H 125

## 93438 NADELA

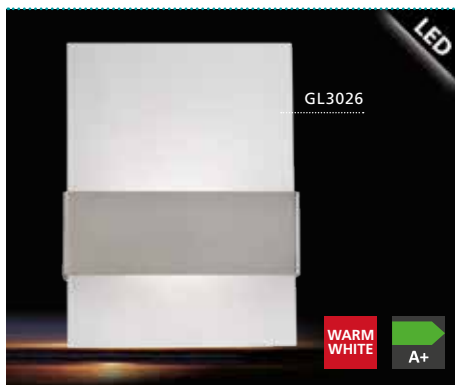

wall luminaire; stainless steel, stainless steel / satinated glass, white  
Wandleuchte; Edelstahl, edelstahl / Glas satiniert, weiss  
applique; acier inoxydable, acier inoxydable / verre satiné, blanc

L 215, H 290, A 90



9 002759 934385



2x 2,5W 360 lm



IP44

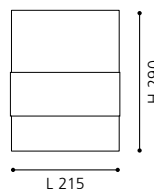

L 215

H 290

## 93316 ESPARTA



wall luminaire; stainless steel, chrome, white  
Wandleuchte; Edelstahl, chrom, weiss  
applique; acier inoxydable, chrome, blanc

L 245, H 170, A 85



9 002759 933166



2x 2,5W 360 lm



IP44

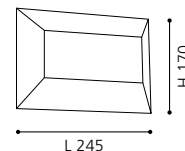

L 245

H 170

GL3026

## 93994 PREDAZZO

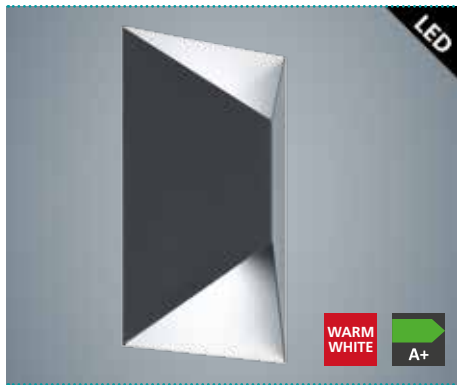

wall luminaire; galvanized steel, anthracite, white  
Wandleuchte; Stahl verzinkt, anthrazit, weiss  
applique; acier galvanisé

L 140, H 210, A 75



9 002759 939946



2x 2,5W 360 lm



IP44

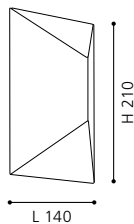

L 140

H 210

## 93993 PREDAZZO



wall luminaire; galvanized steel, silver, white  
Wandleuchte; Stahl verzinkt, silber, weiss  
applique; acier galvanisé, argent, blanc

L 140, H 210, A 75



9 002759 939939



2x 2,5W 360 lm



IP44

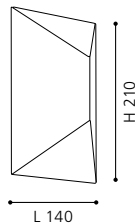

L 140

H 210

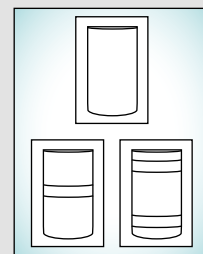

## 89366

This luminaire comes with adjustable design elements made of stainless steel.

Diese Leuchte wird mit verstellbaren Zierelementen aus Edelstahl ausgeliefert.

Ce luminaire vient avec éléments de décoration interchangeables en acier inoxydable.

## 94119 RAVARINO



wall luminaire; aluminium, silver / plastic, white  
 Wandleuchte; Alu, silber / Kunststoff, weiss  
 applique; aluminium, argent / plastique, blanc

L 140, H 270, A 110



9 002759 941192



4x 2,5W



720 lm



IP44

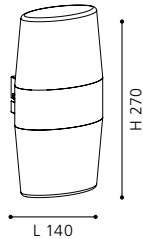

L 140

H 270

## 94124 BENACO

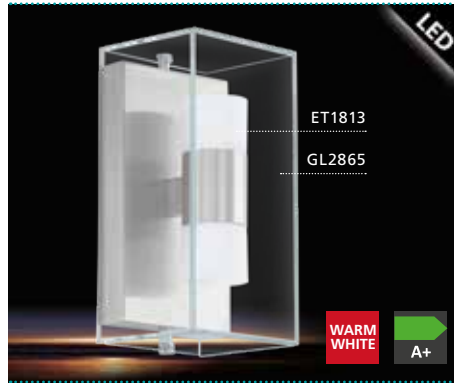

wall luminaire; stainless steel, stainless steel / glass, plastic, clear, white  
 Wandleuchte; Edelstahl, edelstahl / Glas, Kunststoff, klar, weiss  
 applique; acier inoxydable, acier inoxydable / verre, plastique, clair, blanc

L 130, H 250, A 110



9 002759 941246



2x 2,5W



360 lm



IP44

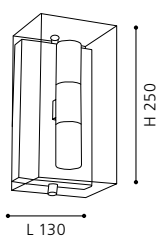

L 130

H 250

## 92342 BENACO



wall luminaire; stainless steel, stainless steel / glass, clear, white  
 Wandleuchte; Edelstahl, edelstahl / Glas, klar, weiss  
 applique; acier inoxydable, acier inoxydable / verre, clair, blanc

L 130, H 250, A 110



9 002759 923426



G9



2x 33W



IP44

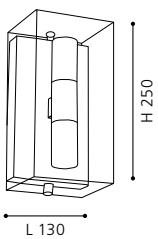

L 130

H 250

GL2865, ET1813

GL2865, GL2866

## 89366 ARCHA



wall luminaire; cast aluminium, stainless steel, satin nickel / corroded glass, white  
 Wandleuchte; Aluguss, edelstahl, nickel-matt / Glas geätzt, weiss  
 applique; aluminium moulé, acier inoxydable, nickel mat / verre rouillé, blanc

L 220, H 330, A 112



9 002759 893668



E27



1x 60W



IP54

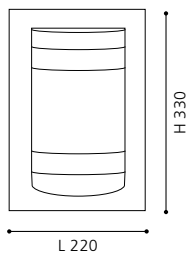

L 220

H 330

GL2073



## 93356 TABO-LED



wall luminaire; stainless steel, stainless steel  
Wandleuchte; Edelstahl, edelstahl  
applique; acier inoxydable, acier inoxydable

L 75, H 305, A 85



9 002759 933562



2,5W 160 lm



IP44

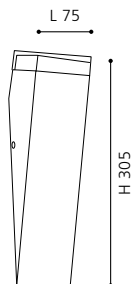

## 93364 TABO-LED



wall luminaire; stainless steel, stainless steel  
Wandleuchte; Edelstahl, edelstahl  
applique; acier inoxydable, acier inoxydable

L 80, H 195, A 110



9 002759 933647



2x 2,5W 320 lm



IP44

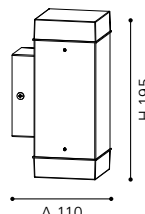

## 93365 PIAS



wall luminaire; stainless steel, stainless steel  
Wandleuchte; Edelstahl, edelstahl  
applique; acier inoxydable, acier inoxydable

L 150, H 250, A 55



9 002759 933654



2x 2,5W 320 lm



IP44

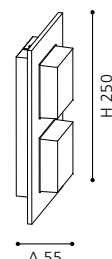

## 93369 PARDELA 1



wall luminaire; stainless steel, stainless steel  
Wandleuchte; Edelstahl, edelstahl  
applique; acier inoxydable, acier inoxydable

L 170, H 280, A 100



9 002759 933692



1x 2,5W 160 lm



IP44

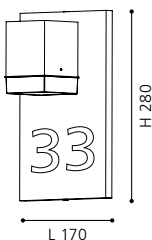

93369



1x

3x

A-F 0-9

Letters and numbers included in delivery.

Buchstaben und Zahlen im Lieferumfang enthalten.

Les lettres et les nombres sont inclus dans la livraison.



LED





LED



#### 94186, 88572

These luminaires come with lighting that is directed upwards as well as downwards.

Diese Leuchten sind sowohl mit nach oben als auch mit nach unten gerichteten Leuchten ausgestattet.

*Ces luminaires brillent non seulement vers le bas, mais aussi vers la haut.*

## 94184 TABO



ceiling luminaire; aluminium, silver  
Deckenleuchte; Alu, silber  
plafonnier; aluminium, argent

L 80, B 80, H 135



9 002759 941840



1x 3,7W



320 lm



IP44

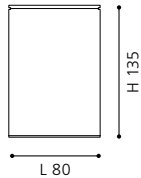

## 94185 TABO



wall luminaire; aluminium, silver  
Wandleuchte; Alu, silber  
applique; aluminium, argent

L 75, B 75, H 140, A 105



9 002759 941857



1x 3,7W



320 lm



IP44

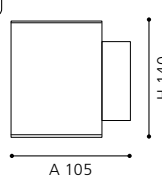

## 94186 TABO



wall luminaire; aluminium, silver  
Wandleuchte; Alu, silber  
applique; aluminium, argent

L 75, B 75, H 195, A 105



9 002759 941864



2x 3,7W



640 lm



IP44

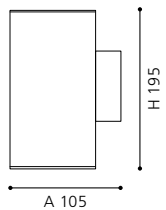

## 88572 TABO 1



wall luminaire; aluminium, silver / glass, clear  
Wandleuchte; Alu, silber / Glas, klar  
applique; aluminium, argent / verre, clair

L 80, H 80, A 150



9 002759 885724



G9



1x 33W



IP44

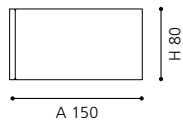

LED

93255 FONTELA

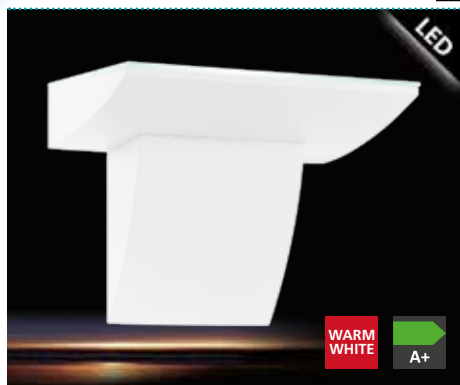

wall luminaire; cast aluminium, white  
Wandleuchte; Aluguss, weiss  
applique; aluminium moulé, blanc

L 240, H 175, A 140



9 002759 932558



2x 2,5W



360 lm



L 240



IP44

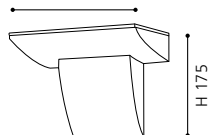

93317 PARDELA



wall luminaire; galvanized steel, white  
Wandleuchte; Stahl verzinkt, weiss  
applique; acier galvanisé, blanc

L 165, H 190, A 95



9 002759 933173



2x 2,5W



360 lm



IP44

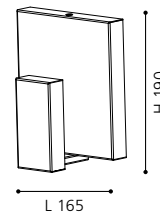



93995 RUSTEGA



wall luminaire; galvanized steel, white  
Wandleuchte; Stahl verzinkt, weiss  
applique; acier galvanisé, blanc

L 210, H 65, A 105



9 002759 939953



2x 2,5W



360 lm



IP44

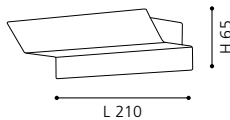

93997 RUSTEGA

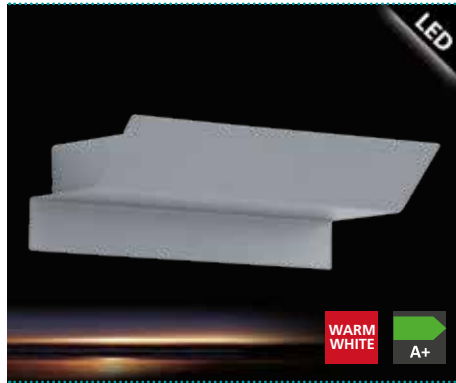

wall luminaire; galvanized steel, silver  
Wandleuchte; Stahl verzinkt, silber  
applique; acier galvanisé, argent

L 210, H 65, A 105



9 002759 939977



2x 2,5W



360 lm



IP44

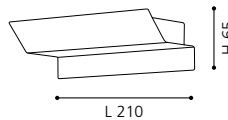

93996 RUSTEGA

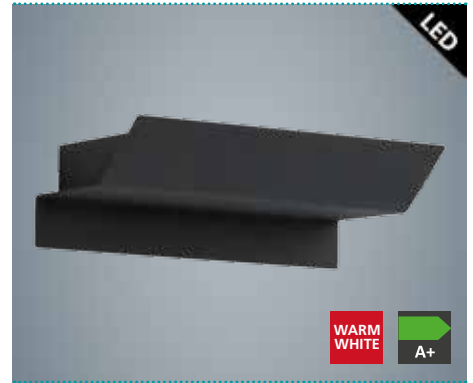

wall luminaire; galvanized steel, anthracite  
Wandleuchte; Stahl verzinkt, anthrazit  
applique; acier galvanisé, anthracite

L 210, H 65, A 105



9 002759 939960



2x 2,5W



360 lm



IP44

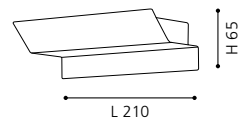

93325 PIAS



wall luminaire; aluminium, white  
Wandleuchte; Alu, weiss  
applique; aluminium, blanc

L 110, H 210, A 100



9 002759 933258



1x 2,5W



160 lm



IP44

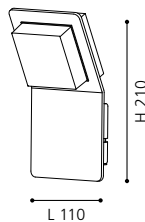

93326 PIAS



wall luminaire; aluminium, white  
Wandleuchte; Alu, weiss  
applique; aluminium, blanc

L 130, H 250, A 95



9 002759 933265



1x 2,5W



180 lm



1x 2,5W



160 lm



IP44

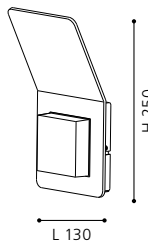

## 93485 NORIKA 1



wall luminaire; cast aluminium, silver / satinated glass, white, clear  
 Wandleuchte; Aluguss, silber / Glas satiniert, weiss, klar  
 applique; aluminium moulé, argent / verre satiné, blanc, clair

L 180, H 115, A 95



9 002759 934859



4x 2,5W 720 lm



IP44

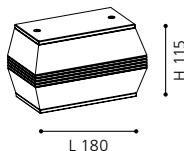

L 180

H 115

GL3027

## 91096 MORINO



wall / ceiling luminaire; cast aluminium, silver, white  
 Wand- / Deckenleuchte; Aluguss, silber, weiss  
 applique / plafonnier; aluminium moulé, argent, blanc

L 140, H 280, A 125



9 002759 910969



4x 4,76W 840 lm



IP44

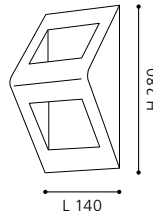

L 140

H 280

## 86993 ARKTIC



wall luminaire; stainless steel, stainless steel / satinated glass, white  
 Wandleuchte; Edelstahl, edelstahl / Glas satiniert, weiss  
 applique; acier inoxydable, acier inoxydable / verre satiné, blanc

L 180, H 237, A 105



9 002759 869939



E27 1x 60W IP44

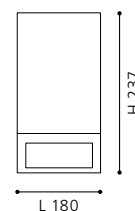

L 180

H 237

GL1184





91769 VOLPINO



wall luminaire; galvanized steel, silver / plastic, white  
Wandleuchte; Stahl verzinkt, silber / Kunststoff, weiss  
applique; acier galvanisé, argent / plastique, blanc

L 290, H 115, A 60

9 002759 917692

LED 2x 6W 840 lm

IP44

94117 CORFINO



wall luminaire; galvanized steel, silver  
Wandleuchte; Stahl verzinkt, silber  
applique; acier galvanisé, argent

L 265, H 210, A 85

9 002759 941178

LED 4x 2,5W 720 lm

IP44

94116 CORFINO



wall luminaire; galvanized steel, silver  
Wandleuchte; Stahl verzinkt, silber  
applique; acier galvanisé, argent

L 135, H 210, A 65

9 002759 941161

LED 2x 2,5W 360 lm

IP44

93488 MORINO



wall luminaire; cast aluminium, silver / satinated glass, white  
Wandleuchte; Aluguss, silber / Glas satiniert, weiss  
applique; aluminium moulé, argent / verre satiné, blanc

L 160, H 235, A 80

9 002759 934880

LED 3x 2,5W 540 lm

IP44

GL3028, GL3029



93488

This luminaire can be mounted in two positions.

Diese Leuchte kann in zwei Varianten montiert werden.

Ce luminaire peut être monté de deux manières.

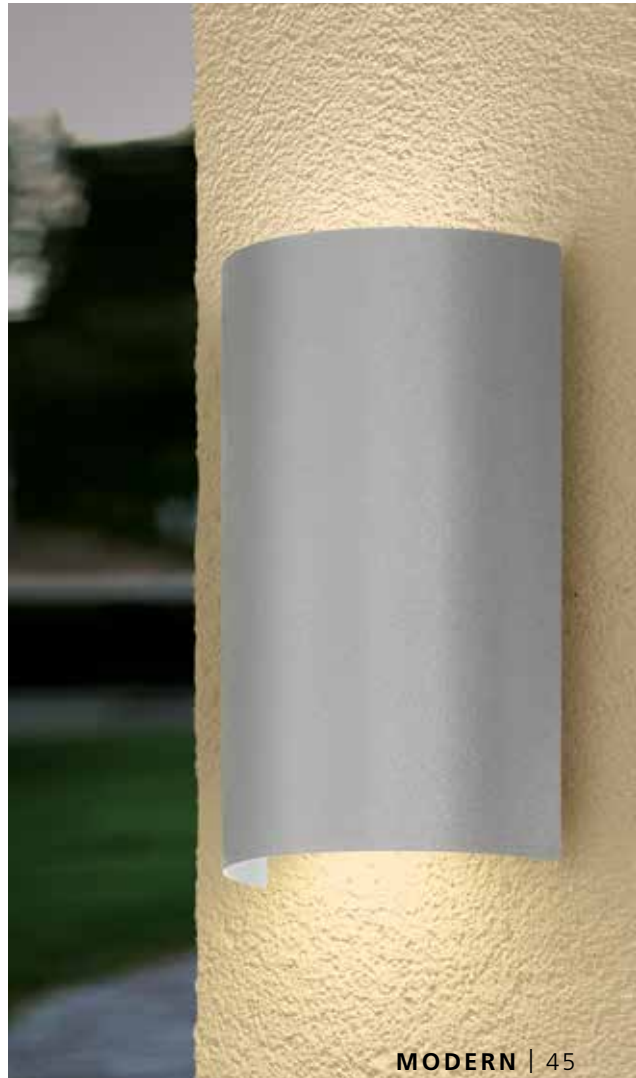

LED

## 94138 BREGANZO



wall luminaire; galvanized steel, anthracite / plastic, white  
Wandleuchte; Stahl verzinkt, anthrazit / Kunststoff, weiss  
applique; acier galvanisé, anthracite / plastique, blanc

## 94137 BREGANZO



wall luminaire; galvanized steel, silver / plastic, white  
Wandleuchte; Stahl verzinkt, silber / Kunststoff, weiss  
applique; acier galvanisé, argent / plastique, blanc

## 83433 PARK



wall luminaire; cast aluminium, anthracite / satinated glass, white  
Wandleuchte; Aluguss, anthrazit / Glas satiniert, weiss  
applique; aluminium moulé, anthracite / verre satiné, blanc

L 180, H 250, A 115



9 002759 941383



2x 2,5W 360 lm



IP44

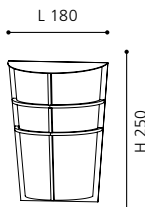

L 180, H 250, A 115



9 002759 941376



2x 2,5W 360 lm



IP44

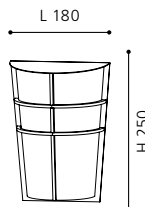

L 200, H 350, A 145



9 002759 834333



E27 1x 60W IP44

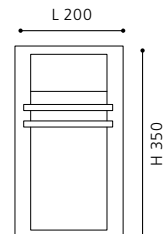

## 83432 PARK



wall luminaire; cast aluminium, silver / satinated glass, white  
Wandleuchte; Aluguss, silber / Glas satiniert, weiss  
applique; aluminium moulé, argent / verre satiné, blanc

L 200, H 350, A 145



9 002759 834326



E27 1x 60W IP44

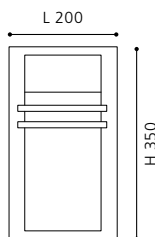

GL-803



## 94133 MALGERA

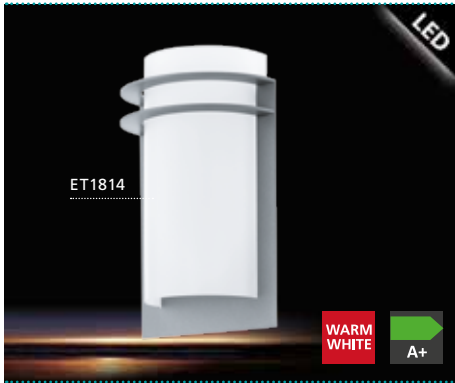

wall luminaire; galvanized steel, silver / plastic, white  
 Wandleuchte; Stahl verzinkt, silber / Kunststoff, weiss  
 applique; acier galvanisé, argent / plastique, blanc

L 170, H 270, A 115



9 002759 941338



2x 2,5W



360 lm



IP44

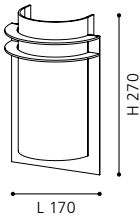

L 170

H 270

ET1814

## 87182 PARK 5



wall luminaire; cast aluminium, silver / satinized glass, white  
 Wandleuchte; Aluguss, silber / Glas satiniert, weiss  
 applique; aluminium moulé, argent / verre satiné, blanc

L 200, H 350, A 100



9 002759 871826



E27



1x 60W



IP44

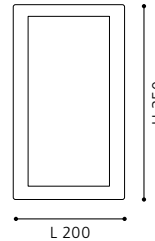

L 200

H 350

GL-804

## 87184 PARK 5



wall luminaire; cast aluminium, anthracite / satinized glass, white  
 Wandleuchte; Aluguss, anthrazit / Glas satiniert, weiss  
 applique; aluminium moulé, anthracite / verre satiné, blanc

L 200, H 350, A 100



9 002759 871840



E27



1x 60W



IP44

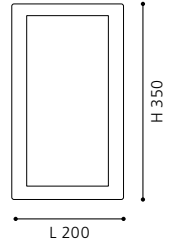

L 200

H 350

GL-804

## 94115 VESCAVA

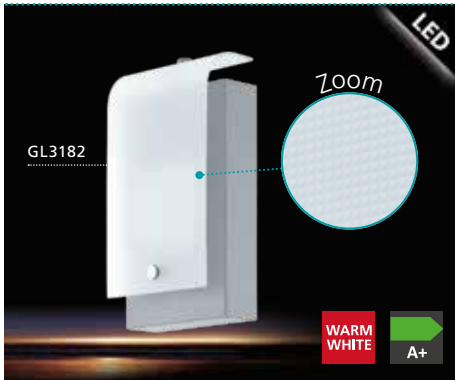

wall luminaire; galvanized steel, silver / structured glass, satinized  
 Wandleuchte; Stahl verzinkt, silber / Glas mit Struktur, satiniert  
 applique; acier galvanisé, argent / verre structuré, satiné

L 120, H 225, A 70



9 002759 941154



1x 3,7W



320 lm



IP44

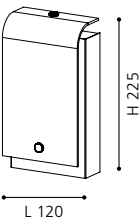

L 120

H 225

GL3182





## 94139 NOCELLA



wall luminaire; cast aluminium, silver / plastic, white  
Wandleuchte; Aluguss, silber / Kunststoff, weiss  
applique; aluminium moulé, argent / plastique, blanc

H 110, Ø 175, A 210



9 002759 941390



2x 2,5W 360 lm



IP44

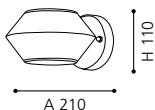

A 210

## 94141 NOCELLA



wall luminaire; cast aluminium, anthracite / plastic, white  
Wandleuchte; Aluguss, anthrazit / Kunststoff, weiss  
applique; aluminium moulé, anthracite / plastique, blanc

H 110, Ø 175, A 210



9 002759 941413



2x 2,5W 360 lm



IP44

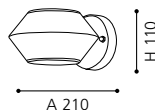

A 210

## 92382 NAGO



wall luminaire; galvanized steel, black  
Wandleuchte; Stahl verzinkt, schwarz  
applique; acier galvanisé, noir

L 110, H 115, A 145



9 002759 923822

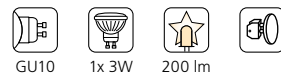

GU10 1x 3W 200 lm



IP44

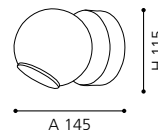

A 145

## 94089 LAVORIA



wall luminaire; galvanized steel, silver / plastic, white  
Wandleuchte; Stahl verzinkt, silber / Kunststoff, weiss  
applique; acier galvanisé, argent / plastique, blanc

L 140, H 130, A 180



9 002759 940898

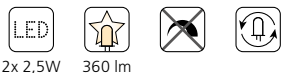

2x 2,5W 360 lm



IP44

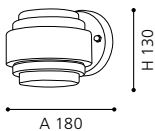

A 180



LED



93267 CITY 2



wall / ceiling luminaire; stainless steel, stainless steel / plastic, white  
Wand- / Deckenleuchte; Edelstahl, edelstahl / Kunststoff, weiss  
applique / plafonnier; acier inoxydable, acier inoxydable / plastique, blanc

Ø 280, A 60

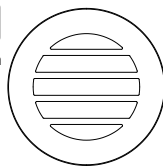

Ø 280

88109 SEVILLA



wall / ceiling luminaire; stainless steel, stainless steel / satinated glass, white  
Wand- / Deckenleuchte; Edelstahl, edelstahl / Glas satiniert, weiss  
applique / plafonnier; acier inoxydable, acier inoxydable / verre satiné, blanc

Ø 285, A 83

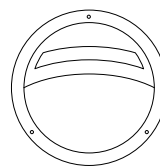

Ø 285

GL1611

88144 CITY



90°, 7 m  
10 - 300 sec.



wall luminaire; stainless steel, stainless steel / plastic, white  
Wandleuchte; Edelstahl, edelstahl / Kunststoff, weiss  
applique; acier inoxydable, acier inoxydable / plastique, blanc

88142 CITY



90°, 7 m  
10 - 300 sec.



wall luminaire; stainless steel, stainless steel / plastic, white  
Wandleuchte; Edelstahl, edelstahl / Kunststoff, weiss  
applique; acier inoxydable, acier inoxydable / plastique, blanc



30194 CITY 1



90°, 7 m  
10 - 240 sec.



wall luminaire; stainless steel, stainless steel / plastic, white  
Wandleuchte; Edelstahl, edelstahl / Kunststoff, weiss  
applique; acier inoxydable, acier inoxydable / plastique, blanc

L 235, H 260, A 90

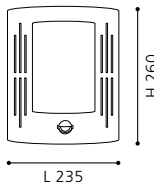

L 235, H 260, A 90

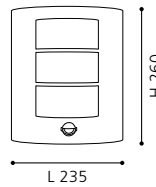

L 235, H 260, A 90

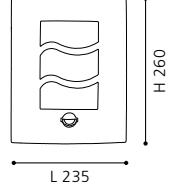

82309 CITY

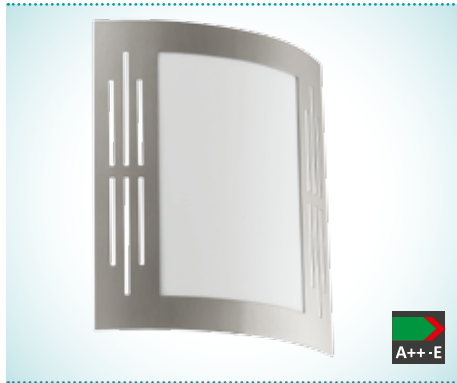

wall luminaire; stainless steel, stainless steel / plastic, white  
Wandleuchte; Edelstahl, edelstahl / Kunststoff, weiss  
applique; acier inoxydable, acier inoxydable / plastique, blanc

88139 CITY



wall luminaire; stainless steel, stainless steel / plastic, white  
Wandleuchte; Edelstahl, edelstahl / Kunststoff, weiss  
applique; acier inoxydable, acier inoxydable / plastique, blanc

30193 CITY 1



wall luminaire; stainless steel, stainless steel / plastic, white  
Wandleuchte; Edelstahl, edelstahl / Kunststoff, weiss  
applique; acier inoxydable, acier inoxydable / plastique, blanc

L 235, H 260, A 90

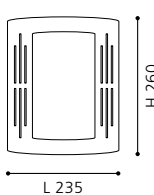

L 235, H 260, A 90

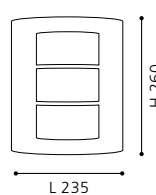

L 235, H 260, A 90

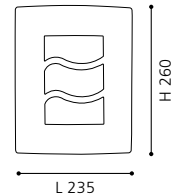
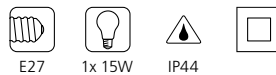





## 94212 CITY LED



wall luminaire; stainless steel, stainless steel / plastic, white  
Wandleuchte; Edelstahl, edelstahl / Kunststoff, weiss  
applique; acier inoxydable, acier inoxydable / plastique, blanc

## 94213 CITY LED



wall luminaire; stainless steel, stainless steel / plastic, white  
Wandleuchte; Edelstahl, edelstahl / Kunststoff, weiss  
applique; acier inoxydable, acier inoxydable / plastique, blanc

## 93258 ISOBA



wall luminaire; cast aluminium, white / plastic, white  
Wandleuchte; Aluguss, weiss / Kunststoff, weiss  
applique; aluminium moulé, blanc / plastique, blanc

L 235, H 260, A 90

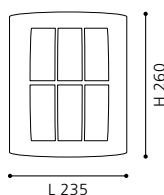

L 235, H 260, A 90

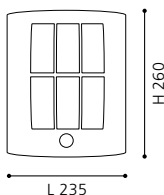
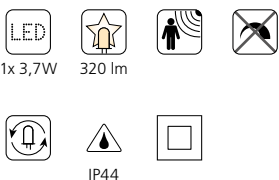

L 160, H 220, A 100

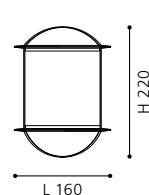

## 93259 ISOBA



wall luminaire; cast aluminium, silver / plastic, white  
Wandleuchte; Aluguss, silber / Kunststoff, weiss  
applique; aluminium moulé, argent / plastique, blanc

L 160, H 220, A 100

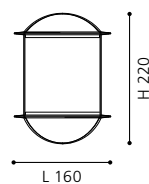

30173 DARIL



wall luminaire; stainless steel, stainless steel / plastic, clear  
**Wandleuchte; Edelstahl, edelstahl / Kunststoff, klar**  
*applique; acier inoxydable, acier inoxydable / plastique, clair*

L 195, H 240, A 110

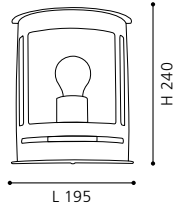
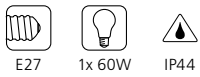

30191 CERNO



wall luminaire; stainless steel, stainless steel / satinated glass, white  
**Wandleuchte; Edelstahl, edelstahl / Glas satiniert, weiss**  
*applique; acier inoxydable, acier inoxydable / verre satiné, blanc*

L 140, H 165, A 105

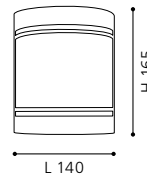

GL2890

30192 CERNO



wall luminaire; stainless steel, stainless steel / satinated glass, white  
**Wandleuchte; Edelstahl, edelstahl / Glas satiniert, weiss**  
*applique; acier inoxydable, acier inoxydable / verre satiné, blanc*

L 140, H 190, A 110

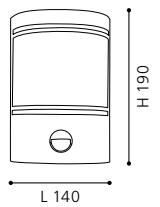

GL2890





89768 ONJA



wall luminaire; cast aluminium, white / ribbed glass, clear  
Wandleuchte; Aluguss, weiss / Glas geriffelt, klar  
applique; aluminium moulé, blanc / verre strié, clair

89769 ONJA



wall luminaire; cast aluminium, silver / ribbed glass, clear  
Wandleuchte; Aluguss, silber / Glas geriffelt, klar  
applique; aluminium moulé, argent / verre strié, clair



89767 ONJA



wall luminaire; cast aluminium, black / ribbed glass, clear  
Wandleuchte; Aluguss, schwarz / Glas geriffelt, klar  
applique; aluminium moulé, noir / verre strié, clair

L 220, H 155, A 150



9 002759 897680

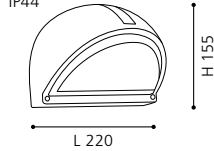

GL2440

L 220, H 155, A 150



9 002759 897697

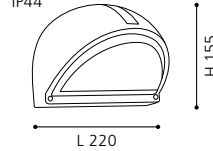

GL2440

L 220, H 155, A 150



9 002759 897673

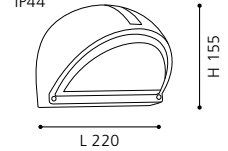

GL2440





LED



30907 VENTO 1



wall / ceiling luminaire; galvanized steel, anthracite / satinated glass, white  
Wand- / Deckenleuchte; Stahl verzinkt, anthrazit / Glas satiniert, weiss  
applique / plafonnier; acier galvanisé, anthracite / verre satiné, blanc

Ø 185, A 60



9 002759 309077

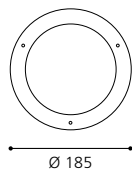

GL1610

94091 VENTO



wall / ceiling luminaire; stainless steel, stainless steel / satinated glass, white  
Wand- / Deckenleuchte; Edelstahl, edelstahl / Glas satiniert, weiss  
applique / plafonnier; acier inoxydable, acier inoxydable / verre satiné, blanc

Ø 185, A 60



9 002759 940911

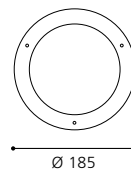

GL1610

94121 VENTO 1



wall / ceiling luminaire; stainless steel, stainless steel / glass, coated white  
Wand- / Deckenleuchte; Edelstahl, edelstahl / Glas, weiss lackiert  
applique / plafonnier; acier inoxydable, acier inoxydable / verre, blanc laqué

Ø 285, A 80



9 002759 941215

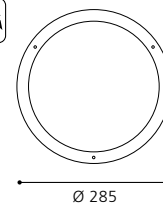

GL3180

93261 SIONES



wall / ceiling luminaire; cast aluminium, white / structured glass, white  
 Wand- / Deckenleuchte; Aluguss, weiss / Glas mit Struktur, weiss  
 applique / plafonnier; aluminium moulé, blanc / verre structuré, blanc

L 145, H 215, A 100



9 002759 932619

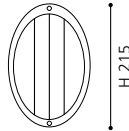

GL2972

93263 SIONES



wall / ceiling luminaire; cast aluminium, white / structured glass, white  
 Wand- / Deckenleuchte; Aluguss, weiss / Glas mit Struktur, weiss  
 applique / plafonnier; aluminium moulé, blanc / verre structuré, blanc

Ø 260, A 100



9 002759 932633

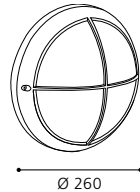

GL2971

88807 ANOLA



wall / ceiling luminaire; plastic, white / glass, clear  
 Wand- / Deckenleuchte; Kunststoff, weiss / Glas, klar  
 applique / plafonnier; plastique, blanc / verre, clair

Ø 185, A 100



9 002759 888077

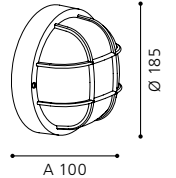
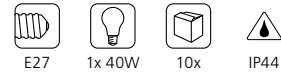

88803 ANOLA



wall / ceiling luminaire; plastic, black / glass, clear  
 Wand- / Deckenleuchte; Kunststoff, schwarz / Glas, klar  
 applique / plafonnier; plastique, noir / verre, clair

Ø 185, A 100



9 002759 888039

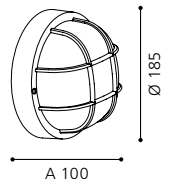
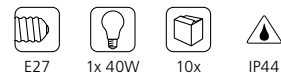

93262 SIONES



wall / ceiling luminaire; cast aluminium, black / structured glass, white  
 Wand- / Deckenleuchte; Aluguss, schwarz / Glas mit Struktur, weiss  
 applique / plafonnier; aluminium moulé, noir / verre structuré, blanc

L 145, H 215, A 100



9 002759 932626

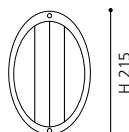

GL2972

93264 SIONES



wall / ceiling luminaire; cast aluminium, black / structured glass, white  
 Wand- / Deckenleuchte; Aluguss, schwarz / Glas mit Struktur, weiss  
 applique / plafonnier; aluminium moulé, noir / verre structuré, blanc

Ø 260, A 100



9 002759 932640

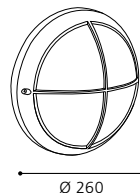

GL2971

88806 ANOLA



wall / ceiling luminaire; plastic, white / glass, clear  
Wand- / Deckenleuchte; Kunststoff, weiss / Glas, klar  
applique / plafonnier; plastique, blanc / verre, clair

L 203, B 113, A 94

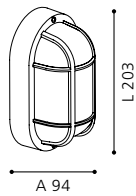

88802 ANOLA



wall / ceiling luminaire; plastic, black / glass, clear  
Wand- / Deckenleuchte; Kunststoff, schwarz / Glas, klar  
applique / plafonnier; plastique, noir / verre, clair

L 203, B 113, A 94

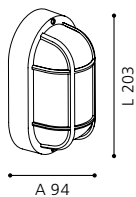



30913 NAGO



wall luminaire; steel, hot-dip galvanised  
Wandleuchte; Stahl, feuerverzinkt  
applique; acier, galvanisé à chaud

L 110, H 115, A 145

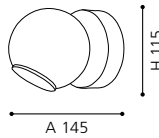

88489 MILTON



wall luminaire; steel, hot-dip galvanised / glass, clear  
Wandleuchte; Stahl, feuerverzinkt / Glas, klar  
applique; acier, galvanisé à chaud / verre, clair

H 310, A 310

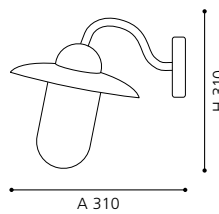

88119 SEVILLA



wall / ceiling luminaire; steel, hot-dip galvanised / satinated glass, white  
Wand- / Deckenleuchte; Stahl, feuerverzinkt / Glas satiniert, weiss  
applique / plafonnier; acier, galvanisé à chaud / verre satiné, blanc

Ø 285, A 83

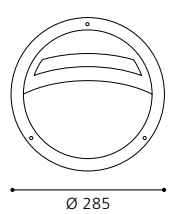
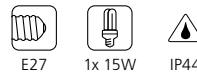

88487 CITY



wall luminaire; stainless steel, hot-dip galvanised / plastic, white  
Wandleuchte; Edelstahl, feuerverzinkt / Kunststoff, weiss  
applique; acier inoxydable, galvanisé à chaud / plastique, blanc

L 235, H 260, A 90

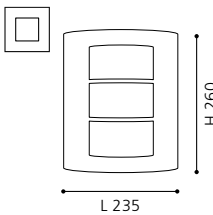

ET0234

90867 LEPUS



wall luminaire; steel, hot-dip galvanised / plastic, white  
Wandleuchte; Stahl, feuerverzinkt / Kunststoff, weiss  
applique; acier, galvanisé à chaud / plastique, blanc

L 235, H 120, A 125

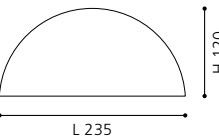

ET1602



15 years guarantee against corrosion on the hot dipped galvanized surface.

15 Jahre Garantie gegen Korrosion der feuerverzinkten Oberfläche.

Garantie de 15 ans contre la corrosion de surface galvanisé à chaud.



# Garden Living





# Overview

## Garden Living



TERRICO  
p. 62



TERRICO  
p. 62



TERRICO  
p. 63



TERRICO  
p. 63



LORENA  
p. 64



LORENA 1  
p. 64



TERRENO  
p. 66



FERROTERRA  
p. 66



KALEO  
p. 68



CATONE  
p. 68



SHUKO  
p. 68



TERRALUNA  
p. 70

94334 TERRICO



floor luminaire; galvanized steel, brown / satinated glass, white  
 Stehleuchte; Stahl verzinkt, braun / Glas satiniert, weiss  
 lampadaire; acier galvanisé, marron / verre satiné, blanc

H 270, Ø 370, Base: Ø 230



IP54

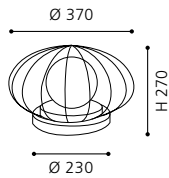

GL1156

94335 TERRICO



floor luminaire; galvanized steel, black / satinated glass, white  
 Stehleuchte; Stahl verzinkt, schwarz / Glas satiniert, weiss  
 lampadaire; acier galvanisé, noir / verre satiné, blanc

H 310, Ø 315, Base: Ø 230



IP54

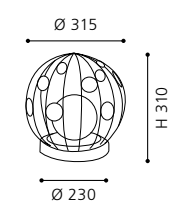

GL1156



94332 TERRICO



94333 TERRICO



GL2720



floor luminaire; galvanized steel, brown / satinated glass, white  
**Stehleuchte; Stahl verzinkt, braun / Glas satiniert, weiss**  
*lampadaire; acier galvanisé, marron / verre satiné, blanc*



GL1156



floor luminaire; galvanized steel, black / satinated glass, white  
**Stehleuchte; Stahl verzinkt, schwarz / Glas satiniert, weiss**  
*lampadaire; acier galvanisé, noir / verre satiné, blanc*

H 750, Ø 230, Base: Ø 230

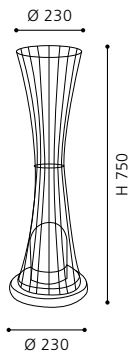

H 580, Ø 305, Base: Ø 230

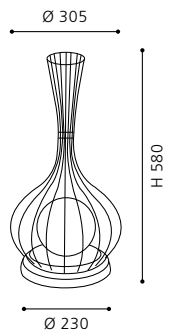

GL2720

GL1156



89173 LORENA



GL-805

floor luminaire; galvanized steel, antique brown / opal glass, white  
 Stehleuchte; Stahl verzinkt, antik-braun / Glas opal-matt, weiss  
 lampadaire; acier galvanisé, marron antique / verre opale, blanc

H 1130, Ø 600, Base: Ø 250



9 002759 891732

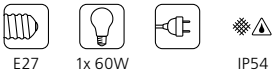

GL-805

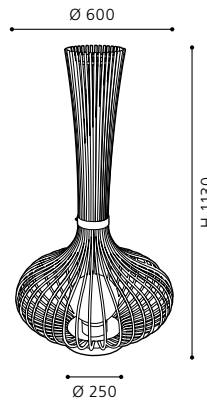

89326 LORENA 1



GL2091

floor luminaire; galvanized steel, antique brown / glass, champagne  
 Stehleuchte; Stahl verzinkt, antik-braun / Glas, champagne  
 lampadaire; acier galvanisé, marron antique / verre, champagne

H 580, Ø 215, Base: Ø 180



9 002759 893262

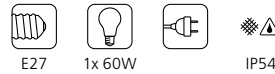

GL2091

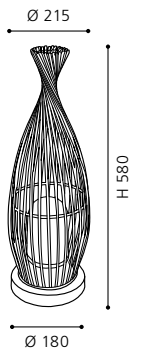









floor luminaire; galvanized steel, black, patina silver / opal glass, white  
 Stehleuchte; Stahl verzinkt, schwarz, silber-patina / Glas opal-matt, weiss  
 lampadaire; acier galvanisé, noir, argent patiné / verre opale, blanc

H 900, Ø 380



9 002759 914363

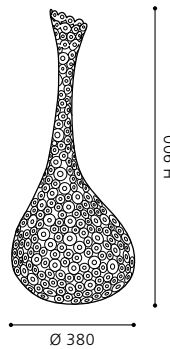
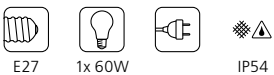

GL-805

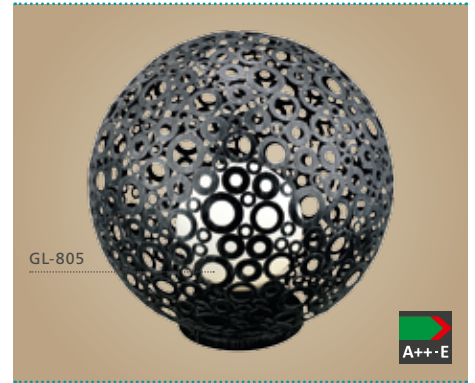

floor luminaire; galvanized steel, black, patina silver / opal glass, white  
 Stehleuchte; Stahl verzinkt, schwarz, silber-patina / Glas opal-matt, weiss  
 lampadaire; acier galvanisé, noir, argent patiné / verre opale, blanc

H 450, Ø 452, Base: Ø 195



9 002759 895655

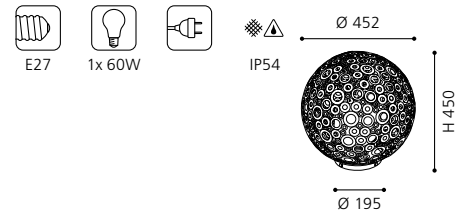

GL-805





91702 KALEO



floor luminaire; galvanized steel, anthracite / opal glass, white  
 Stehleuchte; Stahl verzinkt, anthrazit / Glas opal-matt, weiss  
 lampadaire; acier galvanisé, anthracite / verre opale, blanc

L 190, B 190, H 575

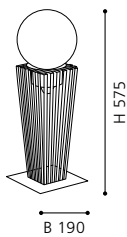
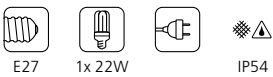

GL-805

92353 CATONE



floor luminaire; galvanized steel, anthracite / plastic, white, clear  
 Stehleuchte; Stahl verzinkt, anthrazit / Kunststoff, weiss, klar  
 lampadaire; acier galvanisé, anthracite / plastique, blanc, clair

H 795, Ø 115, Base: Ø 230

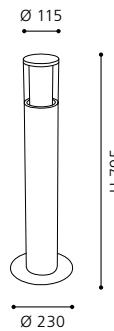
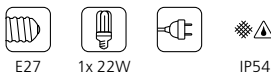

ET1072, ET1416

89562 SHUKO

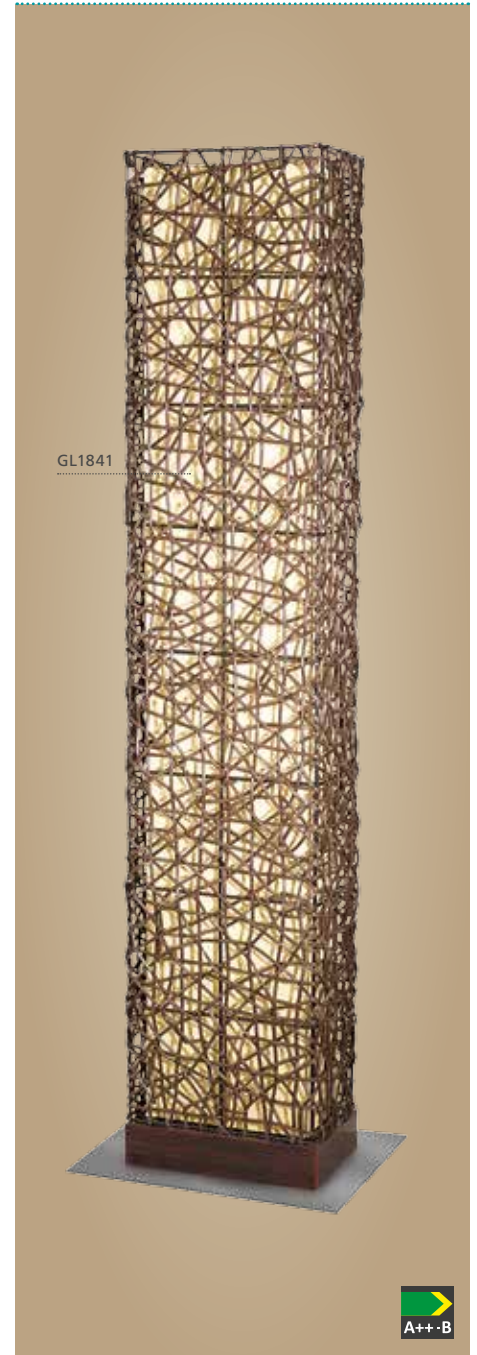

floor luminaire; plastic, dark brown / fabric, beige  
 Stehleuchte; Kunststoff, dunkelbraun / Textil, beige  
 lampadaire; plastique, marron foncé / tissu, beige

L 345, B 260, H 1175

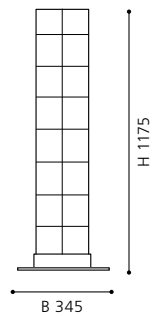
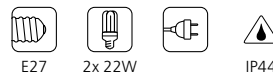

GL1841







89581 TERRALUNA



ET1484  
 floor luminaire; plastic, black / plastic, white  
 Stehleuchte; Kunststoff, schwarz / Kunststoff, weiss  
 lampadaire; plastique, noir / plastique, blanc

89582 TERRALUNA



ET1485  
 floor luminaire; plastic, black / plastic, white  
 Stehleuchte; Kunststoff, schwarz / Kunststoff, weiss  
 lampadaire; plastique, noir / plastique, blanc

89583 TERRALUNA



ET1486  
 floor luminaire; plastic, black / plastic, white  
 Stehleuchte; Kunststoff, schwarz / Kunststoff, weiss  
 lampadaire; plastique, noir / plastique, blanc

H 630, Ø 300, Base: Ø 150



9 002759 895815

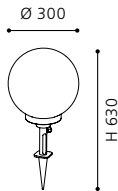
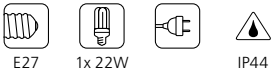

H 735, Ø 400, Base: Ø 150



9 002759 895822

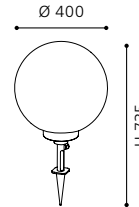
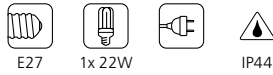

H 820, Ø 480, Base: Ø 150



9 002759 895839

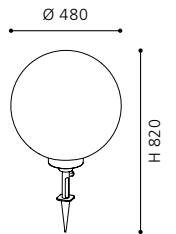
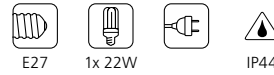

GL1841, ET0727, ET0728, ET0729, ET1484

GL1841, ET0727, ET0728, ET0729, ET1485

GL1841, ET0727, ET0728, ET0729, ET1486



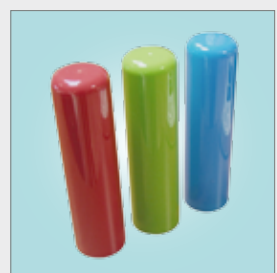

- ET0727
- ET0728
- ET0729

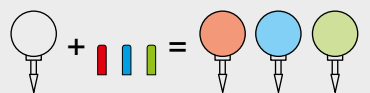

TERRALUNA comes with three different coloured illuminant shades for different lighting effects.

TERRALUNA wird mit 3 verschiedenfarbigen Leuchtmittelabdeckungen für unterschiedliche Lichtstimmungen ausgeliefert.

*TERRALUNA vient avec trois couleurs de connerche pour des effets lumineux différents.*



# Classic





# Overview

## Classic



PATERNO  
p. 74



ALORIA-LED  
p. 76



ALORIA  
p. 76



ALORIA-LED  
p. 78



ALORIA  
p. 79



LISIO  
p. 80



SIDNEY  
p. 82



SIDNEY  
p. 83



EXIT 1  
p. 84



BUCKINGHAM  
p. 85



MILTON  
p. 86



MILTON 1  
p. 86



CERVA  
p. 87



BAREDO  
p. 87



PORTICI  
p. 87



MINORCA  
p. 88



SAN TELMO  
p. 89



RAIANO  
p. 89



OUTDOOR  
CLASSIC  
p. 91



NAVEDO  
p. 93



NAVEDO  
p. 95



LATERNA 4  
p. 96



LATERNA 5  
p. 99



CITY CLASSIC  
p. 100



LATERNA 7  
p. 100



LATERNA 7  
p. 100

LED

94218 PATERNO



floor luminaire; cast aluminium, black / plastic, clear, white  
Stehleuchte; Aluguss, schwarz / Kunststoff, klar, weiss  
lampadaire; aluminium moulé, noir / plastique, clair, blanc

94217 PATERNO



floor luminaire; cast aluminium, black / plastic, clear, white  
Stehleuchte; Aluguss, schwarz / Kunststoff, klar, weiss  
lampadaire; aluminium moulé, noir / plastique, clair, blanc

94215 PATERNO



wall luminaire; cast aluminium, black / plastic, clear, white  
Wandleuchte; Aluguss, schwarz / Kunststoff, klar, weiss  
applique; aluminium moulé, noir / plastique, clair, blanc

L 190, H 230, A 241

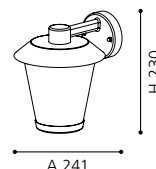

ET1834, ET1835

94216 PATERNO



floor luminaire; cast aluminium, black / plastic, clear, white  
Stehleuchte; Aluguss, schwarz / Kunststoff, klar, weiss  
lampadaire; aluminium moulé, noir / plastique, clair, blanc

L 465, B 425, H 1910

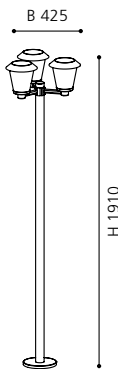

ET1834, ET1835

H 940, Ø 190

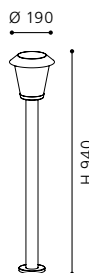

ET1834, ET1835

H 300, Ø 190

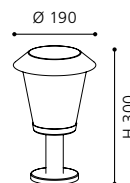

ET1834, ET1835

LED

94214 PATERNO



wall luminaire; cast aluminium, black / plastic, clear, white  
 Wandleuchte; Aluguss, schwarz / Kunststoff, klar, weiss  
 applique; aluminium moulé, noir / plastique, clair, blanc

L 190, H 230, A 241

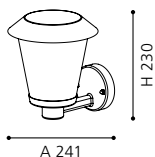

ET1834, ET1835





93512 ALORIA-LED



wall luminaire; cast aluminium, white / plastic, white  
Wandleuchte; Aluguss, weiss / Kunststoff, weiss  
applique; aluminium moulé, blanc / plastique, blanc

93513 ALORIA-LED



wall luminaire; cast aluminium, white / plastic, white  
Wandleuchte; Aluguss, weiss / Kunststoff, weiss  
applique; aluminium moulé, blanc / plastique, blanc

93514 ALORIA-LED



wall luminaire; cast aluminium, white / plastic, white  
Wandleuchte; Aluguss, weiss / Kunststoff, weiss  
applique; aluminium moulé, blanc / plastique, blanc

L 170, H 225, A 190



- GX53
- 1x 7W
- IP44
- 550 lm

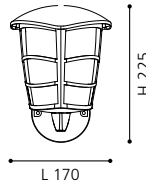

L 170, H 225, A 190



- GX53
- 1x 7W
- IP44
- 550 lm

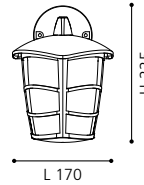

L 180, H 200, A 120



- GX53
- 1x 7W
- IP44
- 550 lm

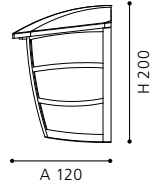

ET1574

ET1574

ET1575

93094 ALORIA



wall luminaire; cast aluminium, white / plastic, clear  
Wandleuchte; Aluguss, weiss / Kunststoff, klar  
applique; aluminium moulé, blanc / plastique, clair

93095 ALORIA



wall luminaire; cast aluminium, white / plastic, clear  
Wandleuchte; Aluguss, weiss / Kunststoff, klar  
applique; aluminium moulé, blanc / plastique, clair

93403 ALORIA



wall luminaire; cast aluminium, white / plastic, clear  
Wandleuchte; Aluguss, weiss / Kunststoff, klar  
applique; aluminium moulé, blanc / plastique, clair

L 170, H 225, A 190



- E27
- 1x 60W
- IP44

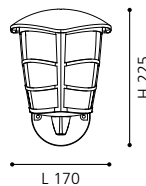

L 170, H 225, A 190



- E27
- 1x 60W
- IP44

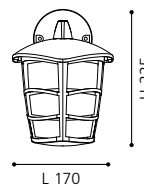

L 180, H 200, A 120



- E27
- 1x 60W
- IP44

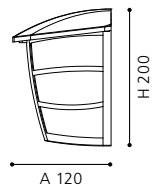

ET1572

ET1572

ET1573

93405 ALORIA



floor luminaire; cast aluminium, white / plastic, clear  
 Stehleuchte; Aluguss, weiss / Kunststoff, klar  
 lampadaire; aluminium moulé, blanc / plastique, clair

93404 ALORIA



floor luminaire; cast aluminium, white / plastic, clear  
 Stehleuchte; Aluguss, weiss / Kunststoff, klar  
 lampadaire; aluminium moulé, blanc / plastique, clair

L 170, B 170, H 940, Base: Ø 170



9 002759 934040



E27



1x 60W



IP44



ET1572

93402 ALORIA



pendant luminaire; cast aluminium, white / plastic, clear  
 Hängeleuchte; Aluguss, weiss / Kunststoff, klar  
 luminaire suspension; aluminium moulé, blanc / plastique, clair

L 170, B 170, H 685



9 002759 934026



E27



1x 60W



IP44

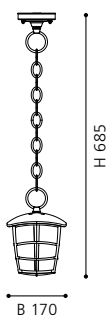

ET1572

93096 ALORIA



pedestal luminaire; cast aluminium, white / plastic, clear  
 Sockelleuchte; Aluguss, weiss / Kunststoff, klar  
 borne; aluminium moulé, blanc / plastique, clair

L 170, B 170, H 300, Base: Ø 170



9 002759 930967



E27



1x 60W



IP44

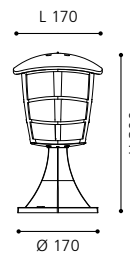

ET1572

H 1800, Ø 480, Base: Ø 215



9 002759 934057



E27



3x 60W



IP44

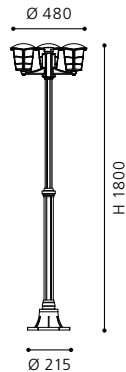

ET1572



LED

93515 ALORIA-LED



wall luminaire; cast aluminium, black / plastic, white  
Wandleuchte; Aluguss, schwarz / Kunststoff, weiss  
applique; aluminium moulé, noir / plastique, blanc

L 170, H 225, A 190

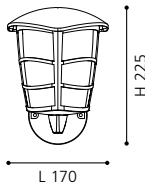

ET1574

93516 ALORIA-LED



wall luminaire; cast aluminium, black / plastic, white  
Wandleuchte; Aluguss, schwarz / Kunststoff, weiss  
applique; aluminium moulé, noir / plastique, blanc

L 170, H 225, A 190

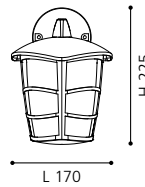

ET1574

93517 ALORIA-LED



wall luminaire; cast aluminium, black / plastic, white  
Wandleuchte; Aluguss, schwarz / Kunststoff, weiss  
applique; aluminium moulé, noir / plastique, blanc

L 180, H 200, A 120

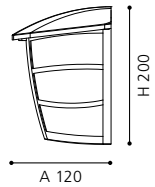

ET1575

93097 ALORIA



wall luminaire; cast aluminium, black / plastic, clear  
Wandleuchte; Aluguss, schwarz / Kunststoff, klar  
applique; aluminium moulé, noir / plastique, clair

L 170, H 225, A 190

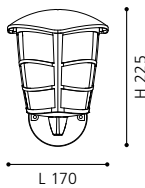

ET1572

93098 ALORIA



wall luminaire; cast aluminium, black / plastic, clear  
Wandleuchte; Aluguss, schwarz / Kunststoff, klar  
applique; aluminium moulé, noir / plastique, clair

L 170, H 225, A 190

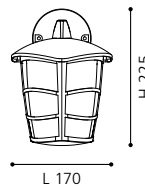

ET1572

93407 ALORIA



wall luminaire; cast aluminium, black / plastic, clear  
Wandleuchte; Aluguss, schwarz / Kunststoff, klar  
applique; aluminium moulé, noir / plastique, clair

L 180, H 200, A 120

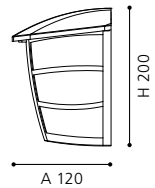

ET1573





93406 ALORIA



pendant luminaire; cast aluminium, black / plastic, clear  
 Hängeleuchte; Aluguss, schwarz / Kunststoff, klar  
 luminaire suspension; aluminium moulé, noir / plastique, clair

L 170, B 170, H 685

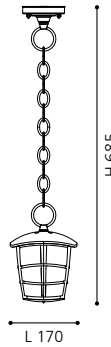

ET1572

93409 ALORIA



floor luminaire; cast aluminium, black / plastic, clear  
 Stehleuchte; Aluguss, schwarz / Kunststoff, klar  
 lampadaire; aluminium moulé, noir / plastique, clair

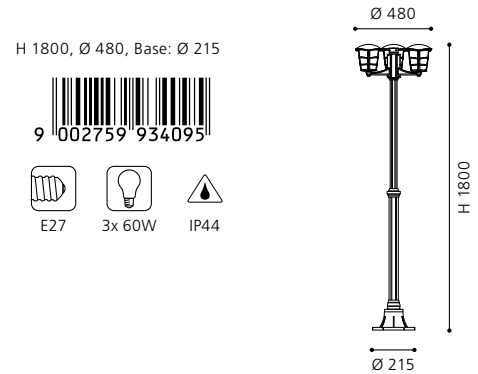

ET1572

93099 ALORIA



pedestal luminaire; cast aluminium, black / plastic, clear  
 Sockelleuchte; Aluguss, schwarz / Kunststoff, klar  
 borne; aluminium moulé, noir / plastique, clair

L 170, B 170, H 300, Base: Ø 170

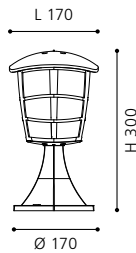

ET1572

93408 ALORIA



floor luminaire; cast aluminium, black / plastic, clear  
 Stehleuchte; Aluguss, schwarz / Kunststoff, klar  
 lampadaire; aluminium moulé, noir / plastique, clair

L 170, B 170, H 940, Base: Ø 170



ET1572

30188 LISIO



floor luminaire; stainless steel, stainless steel / glass, clear  
 Stehleuchte; Edelstahl, edelstahl / Glas, klar  
 lampadaire; acier inoxydable, acier inoxydable / verre, clair

H 1000, Ø 175, Base: Ø 130

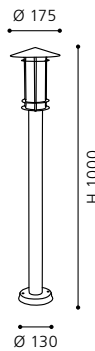

GL2779

30187 LISIO



floor luminaire; stainless steel, stainless steel / glass, clear  
 Stehleuchte; Edelstahl, edelstahl / Glas, klar  
 lampadaire; acier inoxydable, acier inoxydable / verre, clair

H 500, Ø 175, Base: Ø 130

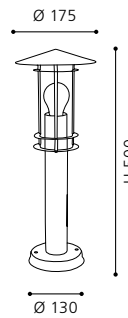

GL2779

30185 LISIO



wall luminaire; stainless steel, stainless steel / glass, clear  
 Wandleuchte; Edelstahl, edelstahl / Glas, klar  
 applique; acier inoxydable, acier inoxydable / verre, clair

90°, 8 m  
 10 - 240 sec.

L 175, H 360, A 225

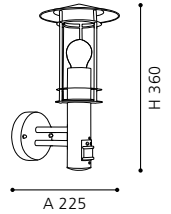
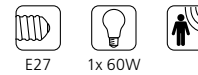

GL2779

30186 LISIO



pendant luminaire; stainless steel, stainless steel / glass, clear  
 Hängeleuchte; Edelstahl, edelstahl / Glas, klar  
 luminaire suspension; acier inoxydable, acier inoxydable / verre, clair

H 880, Ø 175

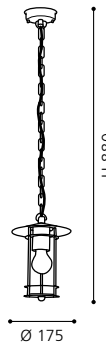

GL2779

30184 LISIO



wall luminaire; stainless steel, stainless steel / glass, clear  
 Wandleuchte; Edelstahl, edelstahl / Glas, klar  
 applique; acier inoxydable, acier inoxydable / verre, clair

L 175, H 300, A 225

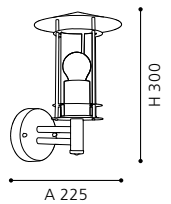

GL2779





87105 SIDNEY



120°, 6 m  
5 - 480 sec.

wall luminaire; stainless steel, stainless steel / satinated glass, white  
Wandleuchte; Edelstahl, edelstahl / Glas satiniert, weiss  
applique; acier inoxydable, acier inoxydable / verre satiné, blanc

H 375, Ø 270, A 325

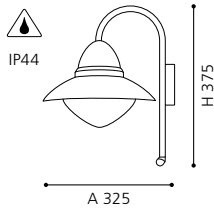
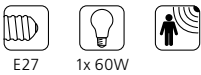

GL-867

83971 SIDNEY

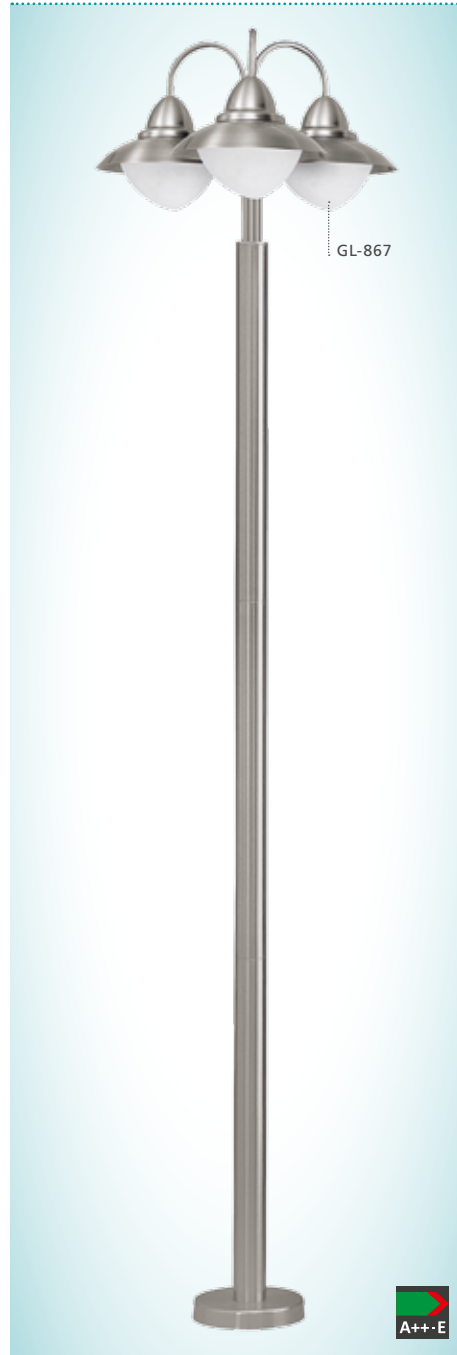

floor luminaire; stainless steel, stainless steel / satinated glass, white  
Stehleuchte; Edelstahl, edelstahl / Glas satiniert, weiss  
lampadaire; acier inoxydable, acier inoxydable / verre satiné, blanc

H 2200, Ø 600, Base: Ø 200

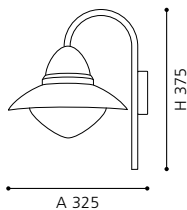

GL-867

83969 SIDNEY



floor luminaire; stainless steel, stainless steel / satinated glass, white  
Stehleuchte; Edelstahl, edelstahl / Glas satiniert, weiss  
lampadaire; acier inoxydable, acier inoxydable / verre satiné, blanc

B 350, H 1200, Base: Ø 120

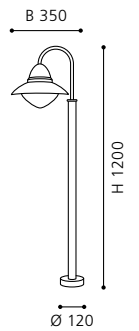
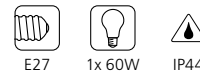

GL-867

83966 SIDNEY



wall luminaire; stainless steel, stainless steel / satinated glass, white  
Wandleuchte; Edelstahl, edelstahl / Glas satiniert, weiss  
applique; acier inoxydable, acier inoxydable / verre satiné, blanc

H 375, Ø 270, A 325

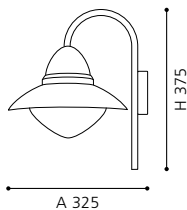

GL-867

83968 SIDNEY



pedestal luminaire; stainless steel, stainless steel / satinated glass, white  
Sockelleuchte; Edelstahl, edelstahl / Glas satiniert, weiss  
borne; acier inoxydable, acier inoxydable / verre satiné, blanc

B 350, H 620, Base: Ø 120

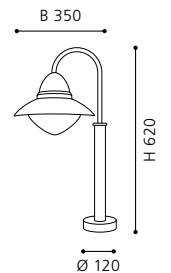

GL-867



**88711 SIDNEY**



120°, 6 m  
5 - 480 sec.

GL-867



wall luminaire; galvanized steel, antique brown / satinated glass, white  
Wandleuchte; Stahl verzinkt, antik-braun / Glas satiniert, weiss  
applique; acier galvanisé, marron antique / verre satiné, blanc

H 375, Ø 275, A 325



E27



1x 60W



IP44

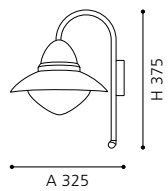

GL-867

**88709 SIDNEY**



E27



1x 60W



IP44

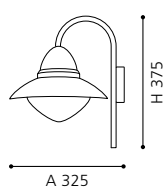

GL-867

80767 EXIT 1



wall luminaire; cast aluminium, white  
Wandleuchte; Aluguss, weiss  
applique; aluminium moulé, blanc

80761 EXIT 1



wall luminaire; cast aluminium, silver  
Wandleuchte; Aluguss, silber  
applique; aluminium moulé, argent

80781 EXIT 1



wall luminaire; cast aluminium, green  
Wandleuchte; Aluguss, grün  
applique; aluminium moulé, vert

L 230, H 285, A 130



9 002759 807672

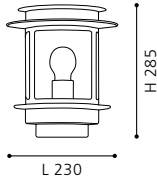

L 230, H 285, A 130



9 002759 807610

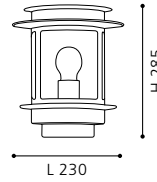

B 230, H 285, A 130



9 002759 807818

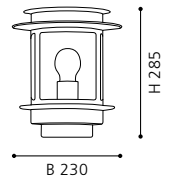
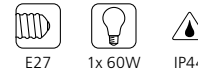



93992 BUCKINGHAM



wall luminaire; galvanized steel, black, patina silver / wavy glass, clear  
Wandleuchte; Stahl verzinkt, schwarz, silber-patina / Glas gewellt, klar  
applique; acier galvanisé, noir, argent patiné / verre ondulé, clair

L 105, H 380, A 160



E27



1x 60W



IP54

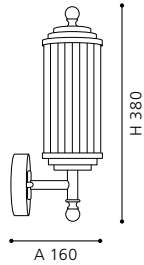

GL2308

90168 BUCKINGHAM



wall luminaire; stainless steel, stainless steel / wavy glass, clear  
Wandleuchte; Edelstahl, edelstahl / Glas gewellt, klar  
applique; acier inoxydable, acier inoxydable / verre ondulé, clair

L 105, H 380, A 160



E27



1x 60W



IP54

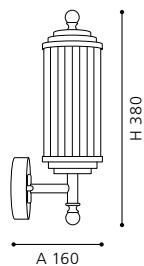

GL2308



83591 MILTON



wall luminaire; galvanized steel, green antique / glass, clear  
 Wandleuchte; Stahl verzinkt, grün-antik / Glas, klar  
 applique; acier galvanisé, vert antique / verre, clair

83589 MILTON



wall luminaire; galvanized steel, antique brown / glass, clear  
 Wandleuchte; Stahl verzinkt, antik-braun / Glas, klar  
 applique; acier galvanisé, marron antique / verre, clair

83588 MILTON



wall luminaire; stainless steel, stainless steel / glass, clear  
 Wandleuchte; Edelstahl, edelstahl / Glas, klar  
 applique; acier inoxydable, acier inoxydable / verre, clair

B 240, H 310, A 300

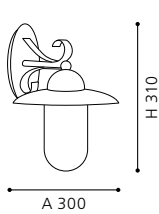

GL-859

B 240, H 310, A 300

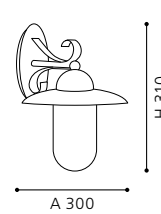
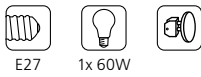

GL-859

B 240, H 310, A 300

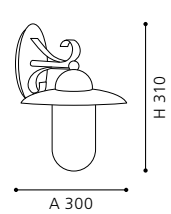

GL-859



83585 MILTON 1



wall luminaire; stainless steel, stainless steel / opal glass, white  
 Wandleuchte; Edelstahl, edelstahl / Glas opal, weiss  
 applique; acier inoxydable, acier inoxydable / verre opale, blanc

B 240, H 310, A 290

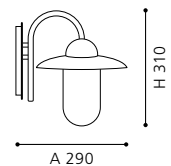

GL-849



92151 CERVA



wall luminaire; stainless steel, stainless steel / plastic, clear  
**Wandleuchte; Edelstahl, edelstahl / Kunststoff, klar**  
*applique; acier inoxydable, acier inoxydable / plastique, clair*

L 175, H 340, A 205

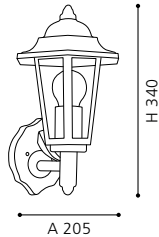
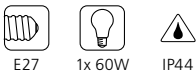

ET1240

92152 CERVA



wall luminaire; stainless steel, stainless steel / plastic, clear  
**Wandleuchte; Edelstahl, edelstahl / Kunststoff, klar**  
*applique; acier inoxydable, acier inoxydable / plastique, clair*

L 175, H 340, A 205

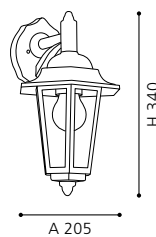

ET1240

93266 BAREDO



wall luminaire; stainless steel, stainless steel / glass, clear  
**Wandleuchte; Edelstahl, edelstahl / Glas, klar**  
*applique; acier inoxydable, acier inoxydable / verre, clair*

L 170, H 190, A 230

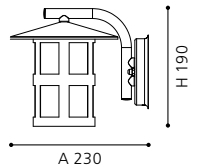

GL2973

90208 PORTICI



wall luminaire; stainless steel, stainless steel / opal glass, white  
**Wandleuchte; Edelstahl, edelstahl / Glas opal-matt, weiss**  
*applique; acier inoxydable, acier inoxydable / verre opale, blanc*

L 140, H 350, A 225

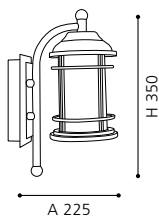
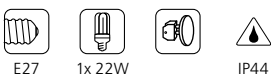

GL2351





89536 MINORCA



floor luminaire; galvanized steel, coppery / opal glass, shiny white  
**Stehleuchte; Stahl verzinkt, kupferfarben / Glas opal, weiss glänzend**  
*lampadaire; acier galvanisé, cuivré / verre opale, blanc brillant*

H 785, Ø 137, Base: Ø 100

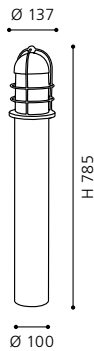

GL2095

89533 MINORCA



wall luminaire; galvanized steel, coppery / opal glass, shiny white  
**Wandleuchte; Stahl verzinkt, kupferfarben / Glas opal, weiss glänzend**  
*applique; acier galvanisé, cuivré / verre opale, blanc brillant*

B 137, H 365, A 185

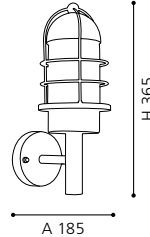
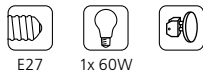

GL2095

89535 MINORCA



pedestal luminaire; galvanized steel, coppery / opal glass, shiny white  
**Sockelleuchte; Stahl verzinkt, kupferfarben / Glas opal, weiss glänzend**  
*borne; acier galvanisé, cuivré / verre opale, blanc brillant*

H 385, Ø 137, Base: Ø 100

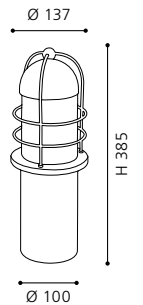
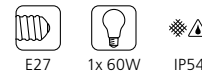

GL2095





90184 SAN TELMO



wall luminaire; galvanized steel, cast aluminium, antique brown / glass with blowholes, clear  
Wandleuchte; Stahl verzinkt, Aluguss, antik-braun / Glas mit Luftschlüssen, klar  
applique; marron antique / verre bullé, clair

L 180, H 350, A 240



E27



1x 60W



IP23

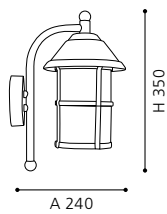

GL2534

91121 RAIANO



wall luminaire; galvanized steel, antique brown / plastic, white  
Wandleuchte; Stahl verzinkt, antik-braun / Kunststoff, weiss  
applique; acier galvanisé, marron antique / plastique, blanc

L 125, H 350, A 170



E27



1x 22W



IP44

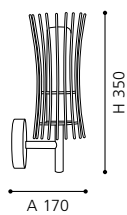

ET0709







4171 OUTDOOR CLASSIC



GL-858

GL-857



floor luminaire; cast aluminium, black-green / glass, clear  
 Stehleuchte; Aluguss, schwarz-grün / Glas, klar  
 lampadaire; aluminium moulé, noir-vert / verre, clair

H 2130, Ø 530, Base: Ø 250



E27



3x 60W



IP23

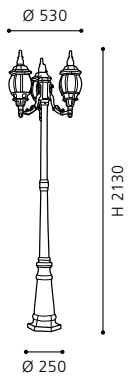

GL-857, GL-858



4172 OUTDOOR CLASSIC



floor luminaire; cast aluminium, black-green / glass, clear  
 Stehleuchte; Aluguss, schwarz-grün / Glas, klar  
 lampadaire; aluminium moulé, noir-vert / verre, clair

H 1200, Ø 190, Base: Ø 150

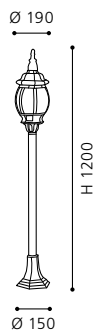

GL-857, GL-858

4174 OUTDOOR CLASSIC



wall luminaire; cast aluminium, black-green / glass, clear  
 Wandleuchte; Aluguss, schwarz-grün / Glas, klar  
 applique; aluminium moulé, noir-vert / verre, clair

B 190, H 530, A 260

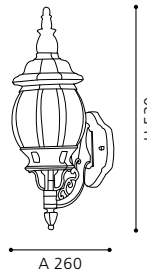

GL-857, GL-858

4175 OUTDOOR CLASSIC



wall luminaire; cast aluminium, black-green / glass, clear  
 Wandleuchte; Aluguss, schwarz-grün / Glas, klar  
 applique; aluminium moulé, noir-vert / verre, clair

B 190, H 480, A 260

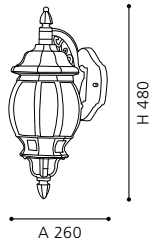
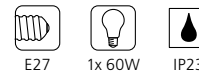

GL-857, GL-858

4173 OUTDOOR CLASSIC



pedestal luminaire; cast aluminium, black-green / glass, clear  
 Sockelleuchte; Aluguss, schwarz-grün / Glas, klar  
 borne; aluminium moulé, noir-vert / verre, clair

H 600, Ø 190, Base: Ø 150



GL-857, GL-858

93465 NAVEDO



GL3005



floor luminaire; cast aluminium, black, patina silver / glass, clear  
 Stehleuchte; Aluguss, schwarz, silber-patina / Glas, klar  
 lampadaire; aluminium moulé, noir, argent patiné / verre, clair

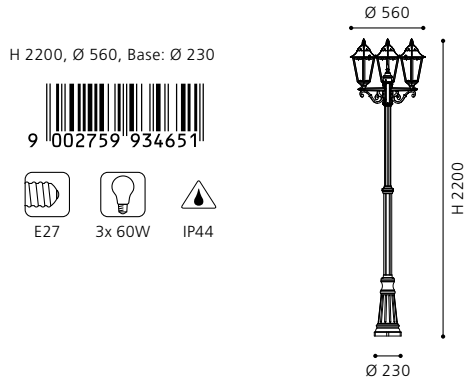

GL3005

93464 NAVEDO



GL3005



floor luminaire; cast aluminium, black, patina silver / glass, clear  
 Stehleuchte; Aluguss, schwarz, silber-patina / Glas, klar  
 lampadaire; aluminium moulé, noir, argent patiné / verre, clair

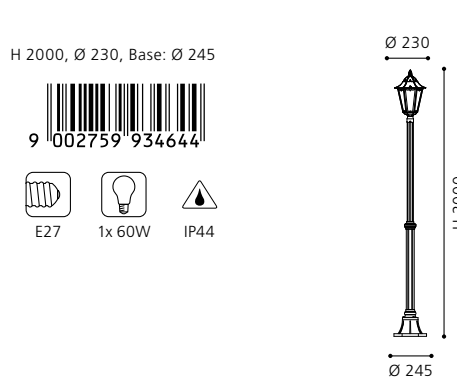

GL3005

93463 NAVEDO



GL3005



floor luminaire; cast aluminium, black, patina silver / glass, clear  
 Stehleuchte; Aluguss, schwarz, silber-patina / Glas, klar  
 lampadaire; aluminium moulé, noir, argent patiné / verre, clair

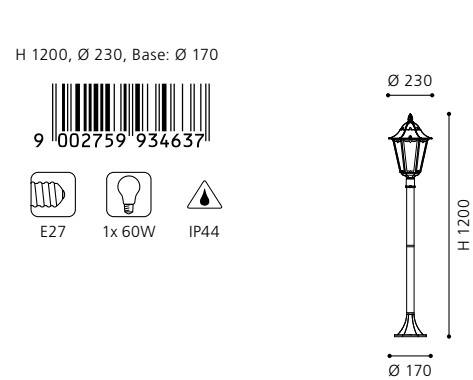

GL3005

93456 NAVEDO



GL3005



wall luminaire; cast aluminium, black, patina silver / glass, clear  
**Wandleuchte; Aluguss, schwarz, silber-patina / Glas, klar**  
*applique; aluminium moulé, noir, argent patiné / verre, clair*

L 200, H 475, A 285



9 002759 934569

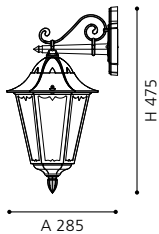

93457 NAVEDO



GL3005



wall luminaire; cast aluminium, black, patina silver / glass, clear  
**Wandleuchte; Aluguss, schwarz, silber-patina / Glas, klar**  
*applique; aluminium moulé, noir, argent patiné / verre, clair*

L 200, H 475, A 285



9 002759 934576

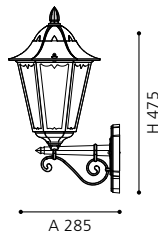

93458 NAVEDO



GL3005



wall luminaire; cast aluminium, black, patina silver / glass, clear  
**Wandleuchte; Aluguss, schwarz, silber-patina / Glas, klar**  
*applique; aluminium moulé, noir, argent patiné / verre, clair*

L 200, H 425, A 285



9 002759 934583

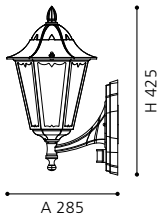

GL3005

GL3005

GL3005

93459 NAVEDO



GL3006



wall luminaire; cast aluminium, black, patina silver / glass, clear  
**Wandleuchte; Aluguss, schwarz, silber-patina / Glas, klar**  
*applique; aluminium moulé, noir, argent patiné / verre, clair*

L 290, H 430, A 130



9 002759 934590

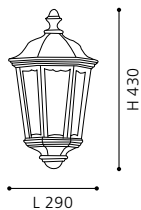

93462 NAVEDO



GL3005



pedestal luminaire; cast aluminium, black, patina silver / glass, clear  
**Sockelleuchte; Aluguss, schwarz, silber-patina / Glas, klar**  
*borne; aluminium moulé, noir, argent patiné / verre, clair*

H 470, Ø 230, Base: Ø 170



9 002759 934620

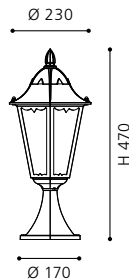

93455 NAVEDO



GL3005



pendant luminaire; cast aluminium, black, patina silver / glass, clear  
**Hängeleuchte; Aluguss, schwarz, silber-patina / Glas, klar**  
*luminaire suspension; aluminium moulé, noir, argent patiné / verre, clair*

H 1045, Ø 230



9 002759 934552

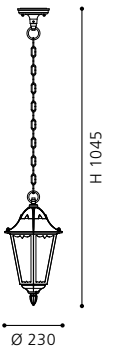

GL3006

GL3005

GL3005



93454 NAVEDO



floor luminaire; cast aluminium, white / glass, clear  
 Stehleuchte; Aluguss, weiss / Glas, klar  
 lampadaire; aluminium moulé, blanc / verre, clair



93453 NAVEDO

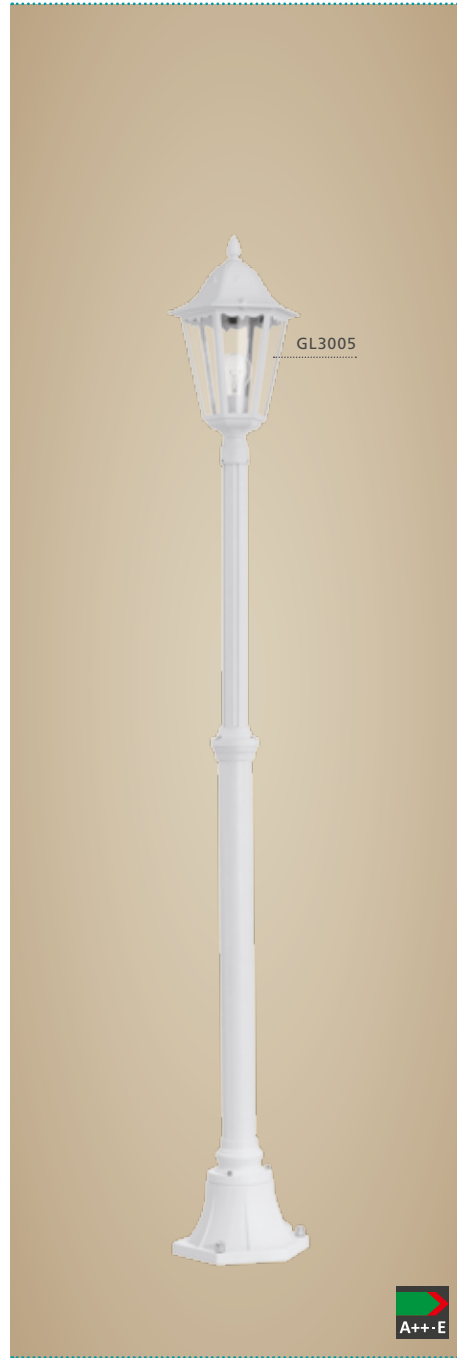

floor luminaire; cast aluminium, white / glass, clear  
 Stehleuchte; Aluguss, weiss / Glas, klar  
 lampadaire; aluminium moulé, blanc / verre, clair



93452 NAVEDO



floor luminaire; cast aluminium, white / glass, clear  
 Stehleuchte; Aluguss, weiss / Glas, klar  
 lampadaire; aluminium moulé, blanc / verre, clair



H 2200, Ø 560, Base: Ø 230

9 002759 934545

E27 3x 60W IP44

H 2200  
Ø 230

GL3005

H 2000, Ø 230, Base: Ø 245

9 002759 934538

E27 1x 60W IP44

H 2000  
Ø 245

GL3005

H 1200, Ø 230, Base: Ø 170

9 002759 934521

E27 1x 60W IP44

H 1200  
Ø 170

GL3005

93445 NAVEDO



wall luminaire; cast aluminium, white / glass, clear  
Wandleuchte; Aluguss, weiss / Glas, klar  
applique; aluminium moulé, blanc / verre, clair

L 200, H 475, A 285

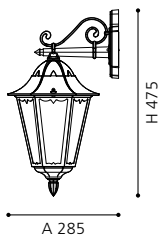
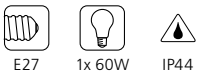

GL3005

93446 NAVEDO



wall luminaire; cast aluminium, white / glass, clear  
Wandleuchte; Aluguss, weiss / Glas, klar  
applique; aluminium moulé, blanc / verre, clair

L 200, H 475, A 285

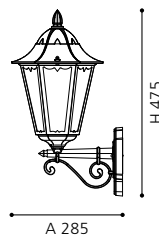

GL3005

93447 NAVEDO



wall luminaire; cast aluminium, white / glass, clear  
Wandleuchte; Aluguss, weiss / Glas, klar  
applique; aluminium moulé, blanc / verre, clair

L 200, H 425, A 285

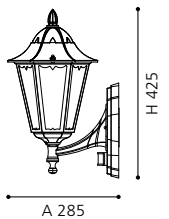

GL3005

93448 NAVEDO



wall luminaire; cast aluminium, white / glass, clear  
Wandleuchte; Aluguss, weiss / Glas, klar  
applique; aluminium moulé, blanc / verre, clair

L 290, H 430, A 130

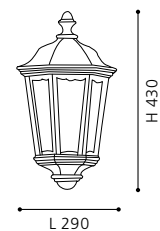

GL3006

93451 NAVEDO



pedestal luminaire; cast aluminium, white / glass, clear  
Sockelleuchte; Aluguss, weiss / Glas, klar  
borne; aluminium moulé, blanc / verre, clair

H 470, Ø 230, Base: Ø 170

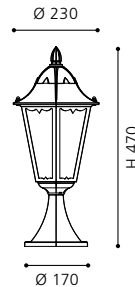

GL3005

93444 NAVEDO



pendant luminaire; cast aluminium, white / glass, clear  
Hängeleuchte; Aluguss, weiss / Glas, klar  
luminaire suspension; aluminium moulé, blanc / verre, clair

H 1045, Ø 230

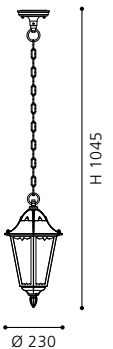

GL3005

22145 LATERNA 4



floor luminaire; cast aluminium, black / glass, clear  
 Stehleuchte; Aluguss, schwarz / Glas, klar  
 lampadaire; aluminium moulé, noir / verre, clair



GL3007

22144 LATERNA 4



floor luminaire; cast aluminium, black / glass, clear  
 Stehleuchte; Aluguss, schwarz / Glas, klar  
 lampadaire; aluminium moulé, noir / verre, clair



GL3007



22471 LATERNA 4



pendant luminaire; cast aluminium, black / glass, clear  
 Hängeleuchte; Aluguss, schwarz / Glas, klar  
 luminaire suspension; aluminium moulé, noir / verre, clair

H 900, Ø 205

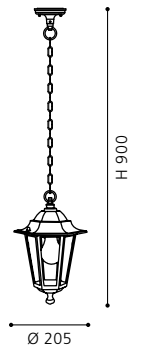
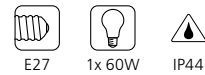

GL3007

22472 LATERNA 4



pedestal luminaire; cast aluminium, black / glass, clear  
 Sockelleuchte; Aluguss, schwarz / Glas, klar  
 borne; aluminium moulé, noir / verre, clair

L 205, B 165, H 405, Base: Ø 170

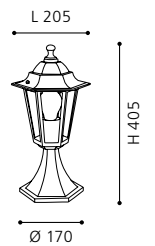

GL3007



22467 LATERNA 4



wall luminaire; cast aluminium, black / glass, clear  
 Wandleuchte; Aluguss, schwarz / Glas, klar  
 applique; aluminium moulé, noir / verre, clair

22468 LATERNA 4



wall luminaire; cast aluminium, black / glass, clear  
 Wandleuchte; Aluguss, schwarz / Glas, klar  
 applique; aluminium moulé, noir / verre, clair

22469 LATERNA 4



wall luminaire; cast aluminium, black / glass, clear  
 Wandleuchte; Aluguss, schwarz / Glas, klar  
 applique; aluminium moulé, noir / verre, clair

L 165, H 350, A 215



9 002759 224677



E27



1x 60W



IP44

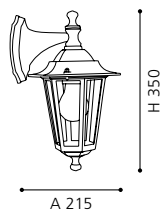

GL3007

L 165, H 350, A 215



9 002759 224684



E27



1x 60W



IP44

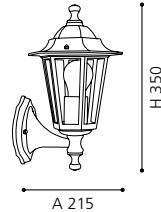

GL3007

L 165, H 425, A 235



9 002759 224691



E27



1x 60W



120°, 8 m  
5 - 540 sec.



IP44

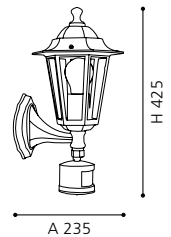

GL3007



22996 LATERNA 5



floor luminaire; cast aluminium, white / glass, clear  
 Stehleuchte; Aluguss, weiss / Glas, klar  
 lampadaire; aluminium moulé, blanc / verre, clair

22995 LATERNA 5



floor luminaire; cast aluminium, white / glass, clear  
 Stehleuchte; Aluguss, weiss / Glas, klar  
 lampadaire; aluminium moulé, blanc / verre, clair

22465 LATERNA 5



pendant luminaire; cast aluminium, white / glass, clear  
 Hängeleuchte; Aluguss, weiss / Glas, klar  
 luminaire suspension; aluminium moulé, blanc / verre, clair

H 900, Ø 205



9 002759 224653



E27



1x 60W



IP44

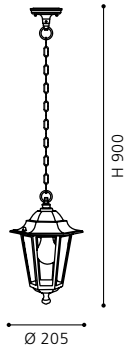

GL3007

22466 LATERNA 5



pedestal luminaire; cast aluminium, white / glass, clear  
 Sockelleuchte; Aluguss, weiss / Glas, klar  
 borne; aluminium moulé, blanc / verre, clair

H 1920, Ø 550, Base: Ø 260



9 002759 229962



E27



3x 60W



IP44

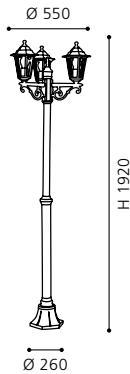

H 1000, Ø 205, Base: Ø 170



9 002759 229955



E27



1x 60W



IP44

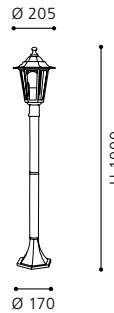

H 405, Ø 205, Base: Ø 170



9 002759 224660



E27



1x 60W



IP44

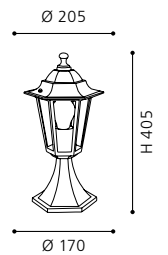

GL3007

GL3007

GL3007

22463 LATERNA 5



wall luminaire; cast aluminium, white / glass, clear  
**Wandleuchte; Aluguss, weiss / Glas, klar**  
*applique; aluminium moulé, blanc / verre, clair*

22462 LATERNA 5



wall luminaire; cast aluminium, white / glass, clear  
**Wandleuchte; Aluguss, weiss / Glas, klar**  
*applique; aluminium moulé, blanc / verre, clair*

22464 LATERNA 5



wall luminaire; cast aluminium, white / glass, clear  
**Wandleuchte; Aluguss, weiss / Glas, klar**  
*applique; aluminium moulé, blanc / verre, clair*

L 165, H 350, A 215

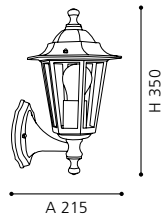

GL3007

L 165, H 350, A 215

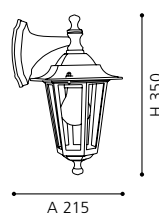

GL3007

L 165, H 425, A 235

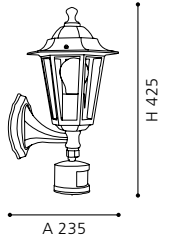
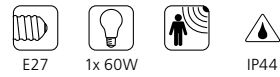

GL3007





88577 CITY CLASSIC



ET0234



wall luminaire; stainless steel, black-gold / plastic, white  
Wandleuchte; Edelstahl, schwarz-gold / Kunststoff, weiss  
applique; acier inoxydable, noir-doré / plastique, blanc

L 235, H 260, A 90



9 002759 885779

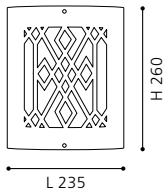

ET0234

3377 LATERNA 7



GL-059



wall luminaire; cast aluminium, white / satinated glass, white  
Wandleuchte; Aluguss, weiss / Glas satiniert, weiss  
applique; aluminium moulé, blanc / verre satiné, blanc

L 155, H 220, A 170



9 002759 337704

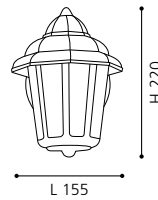

GL-059

3376 LATERNA 7



GL-059



wall luminaire; cast aluminium, black / satinated glass, white  
Wandleuchte; Aluguss, schwarz / Glas satiniert, weiss  
applique; aluminium moulé, noir / verre satiné, blanc

L 155, H 220, A 170



9 002759 337605

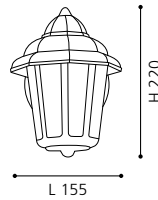
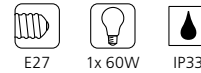

GL-059

5389 LATERNA 7



GL-058



wall / ceiling luminaire; cast aluminium, black / satinated glass, white  
Wand- / Deckenleuchte; Aluguss, schwarz / Glas satiniert, weiss  
applique / plafonnier; aluminium moulé, noir / verre satiné, blanc

Ø 230, A 140



9 002759 538903

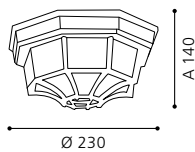

GL-058

5382 LATERNA 7



GL-058



wall / ceiling luminaire; cast aluminium, white / satinated glass, white  
Wand- / Deckenleuchte; Aluguss, weiss / Glas satiniert, weiss  
applique / plafonnier; aluminium moulé, blanc / verre satiné, blanc

Ø 230, A 140



9 002759 538200

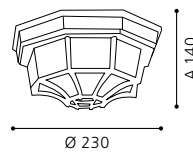

GL-058



# Spots, Recessed, Accessories





# Overview

## Spots, Recessed, Accessories



NEMA  
p. 104



RIGA 1  
p. 104



NEMA 1  
p. 104



NEMA 1  
p. 104



FAEDO  
p. 106



FAEDO  
p. 106



FAEDO  
p. 107



ALEGA  
p. 107



ALEGA  
p. 107



MARGO  
p. 108



LAMEDO  
p. 109



LAMEDO  
p. 109



RIGA 3  
p. 109



RIGA 3  
p. 109



RIGA 3  
p. 109



ZIMBA LED  
p. 110



ZIMBA LED  
p. 110



ZIMBA  
p. 111

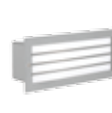

ZIMBA  
p. 111



DETECT ME  
p. 112



CUBA  
p. 112



p. 112



PARK 4  
p. 113



CONNECTOR  
BOX  
p. 113

94111 NEMA



ground spike; stainless steel, stainless steel  
 Erdspieß; Edelstahl, edelstahl  
 spot à piquer; acier inoxydable, acier inoxydable

L 110, B 85, H 240, ET 165

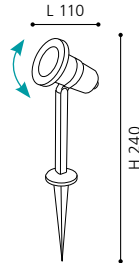
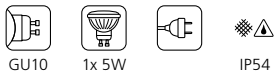

94109 RIGA 1



ground spike; stainless steel, stainless steel  
 Erdspieß; Edelstahl, edelstahl  
 spot à piquer; acier inoxydable, acier inoxydable

B 140, H 630

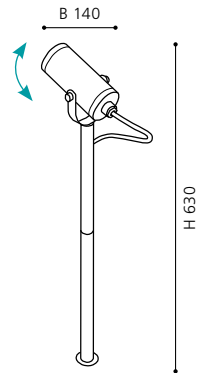
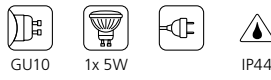

GL2640, GL2641, GL2642, GL2643

93384 NEMA 1



ground spike; plastic, black / plastic, transparent  
 Erdspieß; Kunststoff, schwarz / Kunststoff, transparent  
 spot à piquer; plastique, noir / plastique, transparent

L 115, B 60, H 185

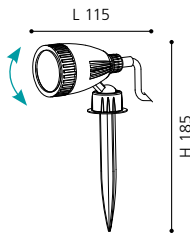
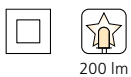
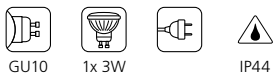

93385 NEMA 1



ground spike; plastic, black / plastic, transparent  
 Erdspieß; Kunststoff, schwarz / Kunststoff, transparent  
 spot à piquer; plastique, noir / plastique, transparent

L 115, B 115, H 180

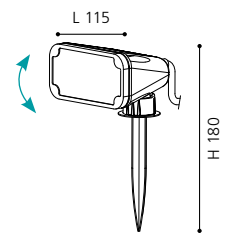
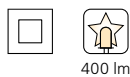
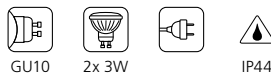

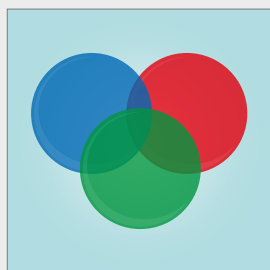

- GL2640
- GL2641
- GL2642
- GL2643

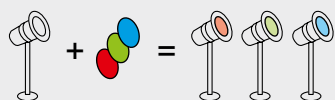

#### 94111

NEMA comes with 3 different coloured bulb shades.

NEMA wird mit 3 verschiedenen farbigen Leuchtmittelabdeckungen ausgeliefert.

*NEMA vient avec 3 couvercles d'ampoule en couleurs différentes.*



93473 FAEDO



wall luminaire; aluminium, silver / glass, clear  
Wandleuchte; Alu, silber / Glas, klar  
applique; aluminium, argent / verre, clair

L 115, H 100, A 95

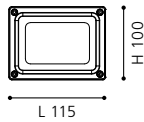

93474 FAEDO



wall luminaire; aluminium, silver / glass, clear  
Wandleuchte; Alu, silber / Glas, klar  
applique; aluminium, argent / verre, clair

L 180, H 155, A 100

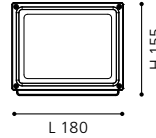

93475 FAEDO



wall luminaire; aluminium, silver / glass, clear  
Wandleuchte; Alu, silber / Glas, klar  
applique; aluminium, argent / verre, clair

L 225, H 250, A 105

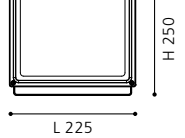

93476 FAEDO



wall luminaire; aluminium, silver / glass, clear  
Wandleuchte; Alu, silber / Glas, klar  
applique; aluminium, argent / verre, clair

L 115, H 150, A 110

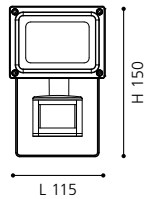
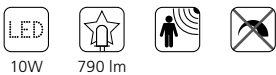

93477 FAEDO



wall luminaire; aluminium, silver / glass, clear  
Wandleuchte; Alu, silber / Glas, klar  
applique; aluminium, argent / verre, clair

L 180, H 155, A 100

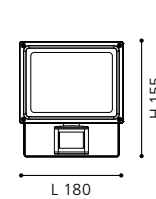
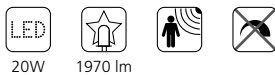

93478 FAEDO



wall luminaire; aluminium, silver / glass, clear  
Wandleuchte; Alu, silber / Glas, klar  
applique; aluminium, argent / verre, clair

L 225, H 250, A 105

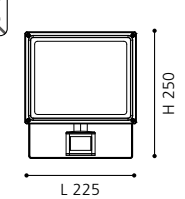
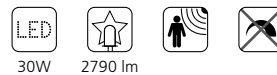

93479 FAEDO



floor luminaire; aluminium, yellow, black / glass, clear  
 Stehleuchte; Alu, gelb, schwarz / Glas, klar  
 lampadaire; aluminium, jaune, noir / verre, clair

L 225, B 100, H 280

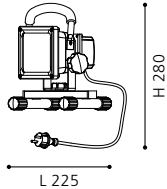

88814 ALEGA



wall luminaire; cast aluminium, black / glass, clear  
 Wandleuchte; Aluguss, schwarz / Glas, klar  
 applique; aluminium moulé, noir / verre, clair

L 140, H 130, A 95

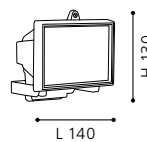

88812 ALEGA



wall luminaire; cast aluminium, black / glass, clear  
 Wandleuchte; Aluguss, schwarz / Glas, klar  
 applique; aluminium moulé, noir / verre, clair

L 185, H 170, A 140

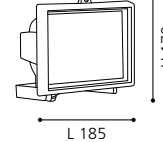

88815 ALEGA



120°, 10 m  
 5 - 540 sec.

wall luminaire; cast aluminium, black / glass, clear  
 Wandleuchte; Aluguss, schwarz / Glas, klar  
 applique; aluminium moulé, noir / verre, clair

L 140, H 180, A 145

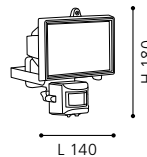

88813 ALEGA



110°, 5 m  
 15 - 420 sec.

wall luminaire; cast aluminium, black / glass, clear  
 Wandleuchte; Aluguss, schwarz / Glas, klar  
 applique; aluminium moulé, noir / verre, clair

L 185, H 265, A 155

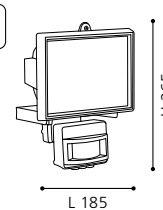

94092 MARGO

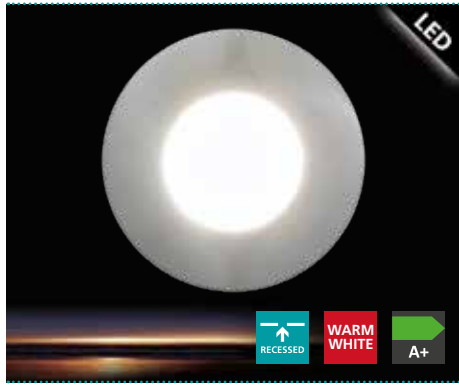

recessed luminaire; cast aluminium, stainless steel / satinated glass, white  
 Einbauleuchte; Aluguss, edelstahl / Glas satiniert, weiss  
 luminaire encastrable; aluminium moulé, acier inoxydable / verre satiné, blanc

H 10, Ø 84, ET 125

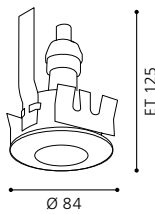

94093 MARGO



recessed luminaire; cast aluminium, white / satinated glass, white  
 Einbauleuchte; Aluguss, weiss / Glas satiniert, weiss  
 luminaire encastrable; aluminium moulé, blanc / verre satiné, blanc

H 10, Ø 84, ET 125

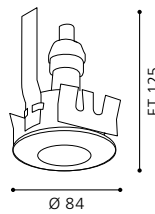

94094 MARGO



recessed luminaire; cast aluminium, coppery / satinated glass, white  
 Einbauleuchte; Aluguss, kupferfarben / Glas satiniert, weiss  
 luminaire encastrable; aluminium moulé, cuivré / verre satiné, blanc

H 10, Ø 84, ET 125

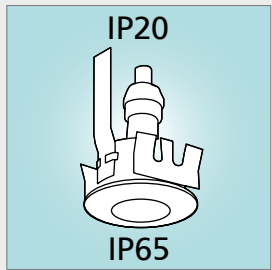
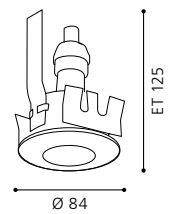
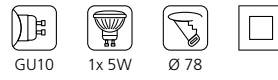

94092, 94093, 94094

These luminaires are protected with IP65 on the frontside and IP20 on the backside.

Diese Leuchten sind mit IP65 frontseitig und IP20 rückseitig geschützt.

Disposent d'un degré de protection élevé IP65 en face avant et IP20 en face arrière pour l'utilisation.





93481 LAMEDO



ground recessed luminaire; stainless steel, stainless steel / satinated glass, white  
**Bodeneinbauleuchte; Edelstahl, edelstahl / Glas satiniert, weiss**  
*luminaire encastrable; acier inoxydable, acier inoxydable / verre satiné, blanc*

93482 LAMEDO



ground recessed luminaire; stainless steel, stainless steel / satinated glass, white  
**Bodeneinbauleuchte; Edelstahl, edelstahl / Glas satiniert, weiss**  
*luminaire encastrable; acier inoxydable, acier inoxydable / verre satiné, blanc*

L 100, B 100, ET 65

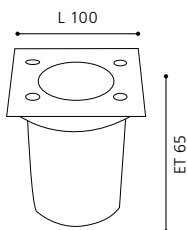
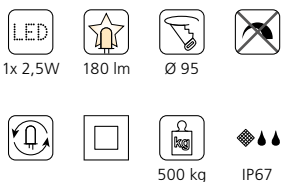

GL3084

Ø 100, ET 65

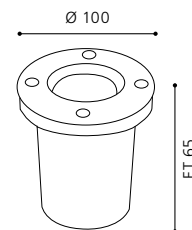
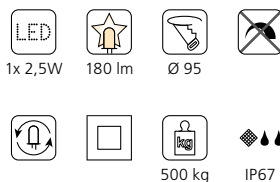

GL3084

86189 RIGA 3



ground recessed luminaire; stainless steel, stainless steel / plastic, white  
**Bodeneinbauleuchte; Edelstahl, edelstahl / Kunststoff, weiss**  
*luminaire encastrable; acier inoxydable, acier inoxydable / plastique, blanc*

H 285, Ø 170

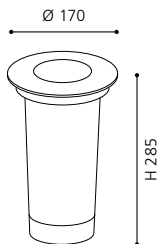
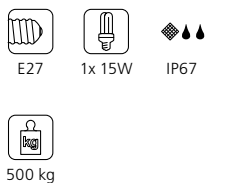

ET0436, GL2438

86188 RIGA 3



ground recessed luminaire; steel, black / plastic, white  
**Bodeneinbauleuchte; Stahl, schwarz / Kunststoff, weiss**  
*luminaire encastrable; acier, noir / plastique, blanc*

H 280, Ø 160

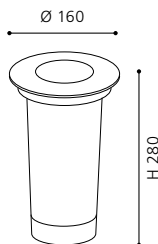
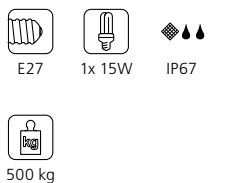

ET0436, GL2438

88063 RIGA 3



ground recessed luminaire; stainless steel, stainless steel / plastic, white  
**Bodeneinbauleuchte; Edelstahl, edelstahl / Kunststoff, weiss**  
*luminaire encastrable; acier inoxydable, acier inoxydable / plastique, blanc*

L 170, B 170, H 260

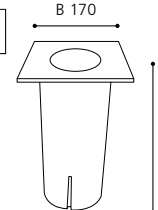

ET0436, GL2438

89544 ZIMBA LED



recessed luminaire; cast aluminium, silver  
 Einbauleuchte; Aluguss, silber  
 luminaire encastrable; aluminium moulé, argent

89543 ZIMBA LED



recessed luminaire; cast aluminium, silver  
 Einbauleuchte; Aluguss, silber  
 luminaire encastrable; aluminium moulé, argent

89545 ZIMBA LED



recessed luminaire; cast aluminium, silver  
 Einbauleuchte; Aluguss, silber  
 luminaire encastrable; aluminium moulé, argent

L 235, B 185, H 5, ET 95



9 002759 895440

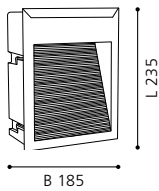

H 5, Ø 125, ET 95



9 002759 895433

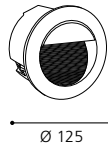
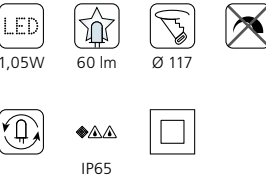

L 140, B 140, H 5, ET 95



9 002759 895457

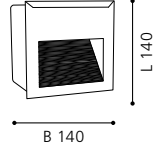
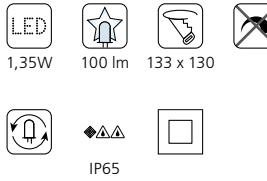



**88575 ZIMBA**



**88576 ZIMBA**

**88008 ZIMBA**



recessed luminaire; cast aluminium, silver / satinated glass, white  
**Einbauleuchte; Aluguss, silber / Glas satiniert, weiss**  
*luminaire encastrable; aluminium moulé, argent / verre satiné, blanc*

recessed luminaire; cast aluminium, silver / satinated glass, white  
**Einbauleuchte; Aluguss, silber / Glas satiniert, weiss**  
*luminaire encastrable; aluminium moulé, argent / verre satiné, blanc*

recessed luminaire; cast aluminium, silver  
**Einbauleuchte; Aluguss, silber**  
*luminaire encastrable; aluminium moulé, argent*

L 227, B 127, H 13, ET 75

L 243, B 101, H 5, ET 100

L 243, B 101, H 5, ET 100



- E14
- 1x 60W
- 196 x 96
- IP44

- E27
- 1x 60W
- 234 x 87
- IP44

- E27
- 1x 60W
- 234 x 87
- IP44

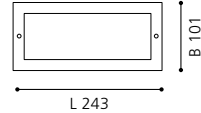
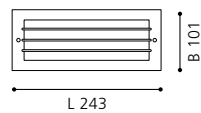
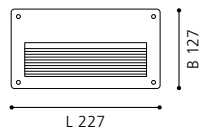

GL1605

GL1605



**30199 DETECT ME**



180°, 10 m  
5 - 240 sec.

accessory; plastic, black  
Zubehör; Kunststoff, schwarz  
accessoire; plastique, noir

**30201 DETECT ME**



180°, 10 m  
5 - 240 sec.

accessory; plastic, white  
Zubehör; Kunststoff, weiss  
accessoire; plastique, blanc

**88744 CUBA**



ground spike; steel, hot-dip galvanised  
Erdspieß; Stahl, feuerverzinkt  
piquet de terre; acier, galvanisé à chaud

L 62, H 82, A 92



9 002759 301996



IP44

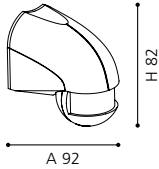

L 62, H 82, A 92



9 002759 302016



IP44

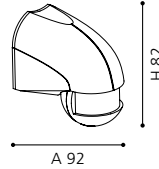

H 300, Ø 185



9 002759 887445



8x

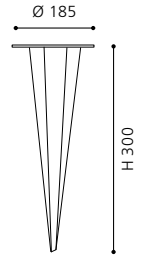

**88153**

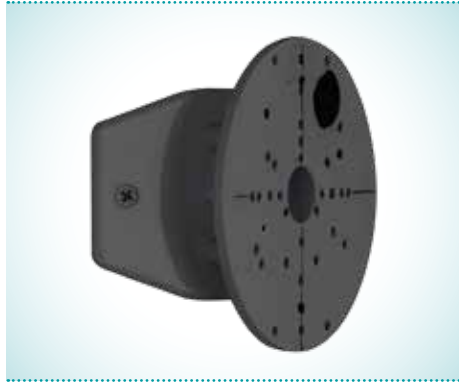

accessory; steel, black  
Zubehör; Stahl, schwarz  
accessoire; acier, noir

Ø 112



9 002759 881535

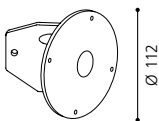

**88152**



accessory; steel, white  
Zubehör; Stahl, weiss  
accessoire; acier, blanc

Ø 112



9 002759 881528

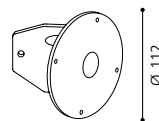

**94112**

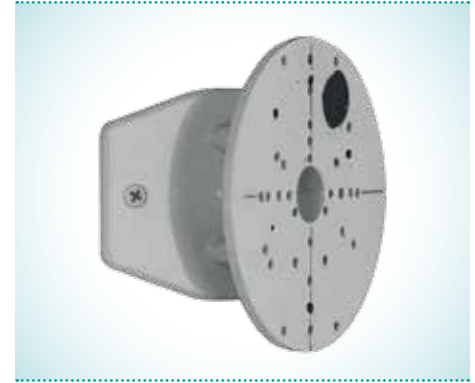

accessory; steel, silver  
Zubehör; Stahl, silber  
accessoire; acier, argent

Ø 112



9 002759 941123

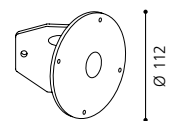



30199, 30201

The DETECT ME sensors are designed for max. 1000 watt when using incandescent lamps or max. 300 watt when using fluorescent lamps.

Die beiden DETECT ME Sensoren sind für max. 1000 Watt bei Glühlampen bzw. max. 300 Watt bei Energiesparlampen ausgelegt.

Les capteurs DETECT ME sont construits pour max 1000 watt lorsqu'il utilise une lampe à incandescence ou max 300 watt lorsqu'il utilise une lampe fluorescente.



88744

With the CUBA ground spike you can stick your floor luminaire in the ground or set it in concrete.

Mit dem CUBA Erdspieß können Sie Ihre Stehleuchte in den Boden stecken oder einbetonieren.

Avec le piquet de terre CUBA vous pouvez fixer votre lampadaire en sol ou au béton.



88152, 88153, 94112

The above mentioned pictogram indicates suitable luminaires which can be easily mounted on corners with this accessories.

Das oben gezeigte Piktogramm markiert passende Leuchten, welche mit dem Zubehör einfach an Ecken montiert werden können.

Le pictogramme ci-dessus marque les luminaires correspondant, qui peut être monté avec les accessoires simples dans les coins.



91206, 91207

No more annoying cables in your garden: bury them simply and safely with the CONNECTOR BOX.

91206: 1 supply line and 2 distribution lines  
91207: 1 supply line and 5 distribution lines

Mit der CONNECTOR BOX können Sie störende Kabel einfach und sicher unter der Erde verschwinden lassen.

91206: 1 Zuleitung und 2 Verteilungsleitungen  
91207: 1 Zuleitung und 5 Verteilungsleitungen

Tous les câbles incommodes disparaissent simplement et sûrement dans votre jardin avec CONNECTOR BOX.

91206: 1 alimentation et 2 lignes de distribution  
91207: 1 alimentation et 5 lignes de distribution

90748 PARK 4



accessory; stainless steel, stainless steel / plastic, green  
Zubehör; Edelstahl, edelstahl / Kunststoff, grün  
accessoire; acier inoxydable, acier inoxydable / plastique, vert

L 115, B 115, H 400, Base: B 160, T 160

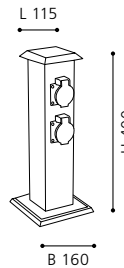
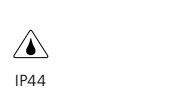

93426 PARK 4



accessory; steel, plastic, black  
Zubehör; Stahl, Kunststoff, schwarz  
accessoire; acier, plastique, noir

L 115, B 115, H 400, Base: B 160, T 160

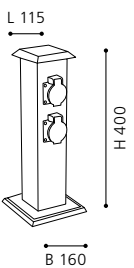
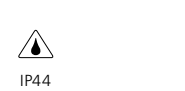

91206 CONNECTOR BOX



accessory; plastic, black  
Zubehör; Kunststoff, schwarz  
accessoire; plastique, noir

H 50, Ø 155

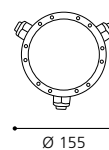

91207 CONNECTOR BOX



accessory; plastic, black  
Zubehör; Kunststoff, schwarz  
accessoire; plastique, noir

H 50, Ø 155

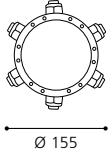

# Register

Number	Page										
Nummer	Seite										
Numéro	Page										
3376	100	83588	86	89562	68	93319	32	93513	76	94133	47
3377	100	83589	86	89565	66	93325	43	93514	76	94137	46
4171	90	83591	86	89581	70	93326	43	93515	78	94138	46
4172	91	83966	82	89582	70	93327	34	93516	78	94139	48
4173	91	83968	82	89583	70	93328	23	93517	78	94141	48
4174	91	83969	82	89767	54	93329	23	93518	26	94184	41
4175	91	83971	82	89768	54	93331	22	93519	26	94185	41
5382	100	83998	19	89769	54	93356	38	93521	26	94186	41
5389	100	84002	19	90119	20	93364	38	93522	26	94208	13
22144	96	86188	109	90121	20	93365	38	93523	26	94209	13
22145	96	86189	109	90168	85	93366	31	93553	31	94212	52
22462	99	86248	15	90184	89	93367	33	93991	35	94213	52
22463	99	86385	15	90208	87	93368	32	93992	85	94214	75
22464	99	86387	25	90748	113	93369	38	93993	36	94215	74
22465	98	86388	25	90867	58	93384	104	93994	36	94216	74
22466	98	86389	25	91096	44	93385	104	93995	43	94217	74
22467	97	86541	15	91121	89	93402	77	93996	43	94218	74
22468	97	86993	44	91206	113	93403	76	93997	43	94277	10
22469	97	87105	82	91207	113	93404	77	93998	35	94278	10
22471	96	87182	47	91436	66	93405	77	93999	35	94279	10
22472	96	87184	47	91702	68	93406	79	94086	35	94281	10
22995	98	88008	111	91769	45	93407	78	94087	24	94332	63
22996	98	88063	109	92151	87	93408	79	94088	24	94333	63
27126	30	88109	49	92152	87	93409	79	94089	48	94334	62
30173	53	88119	58	92335	15	93426	113	94091	55	94335	62
30181	28	88139	50	92336	14	93437	36	94092	108		
30182	28	88142	50	92342	37	93438	36	94093	108		
30183	28	88144	50	92353	68	93444	95	94094	108		
30184	80	88152	112	92382	48	93445	95	94098	17		
30185	80	88153	112	92735	16	93446	95	94099	19		
30186	80	88487	58	92736	16	93447	95	94101	19		
30187	80	88489	58	92737	16	93448	95	94102	19		
30188	80	88572	41	92738	16	93451	95	94103	19		
30191	53	88575	111	93094	76	93452	94	94104	18		
30192	53	88576	111	93095	76	93453	94	94105	18		
30193	50	88577	100	93096	77	93454	94	94106	17		
30194	50	88709	83	93097	78	93455	93	94107	17		
30199	112	88711	83	93098	78	93456	93	94108	17		
30201	112	88744	112	93099	79	93457	93	94109	104		
30205	30	88802	57	93253	35	93458	93	94111	104		
30206	30	88803	56	93254	35	93459	93	94112	112		
30207	30	88806	57	93255	42	93462	93	94114	24		
30907	55	88807	56	93256	34	93463	92	94115	47		
30913	58	88812	107	93258	52	93464	92	94116	45		
80761	84	88813	107	93259	52	93465	92	94117	45		
80767	84	88814	107	93261	56	93473	106	94118	24		
80781	84	88815	107	93262	56	93474	106	94119	37		
81751	23	89173	64	93263	56	93475	106	94121	55		
81752	22	89314	30	93264	56	93476	106	94122	29		
81753	23	89326	64	93266	87	93477	106	94123	29		
82309	50	89366	37	93267	49	93478	106	94124	37		
83278	23	89533	88	93268	21	93479	107	94125	13		
83279	23	89535	88	93269	11	93481	109	94126	13		
83281	22	89536	88	93271	21	93482	109	94127	13		
83432	46	89543	110	93316	36	93485	44	94128	13		
83433	46	89544	110	93317	42	93488	45	94131	11		
83585	86	89545	110	93318	33	93512	76	94132	11		



Name	Page	Name	Page	Name	Page
Name	Seite	Name	Seite	Name	Seite
Nom	Page	Nom	Page	Nom	Seite
ALEGA	107	LORENA 1	64	VENTO	55
ALORIA	76-79	MALGERA	47	VENTO 1	55
ALORIA-LED	76-78	MARGO	108	VESCAVA	47
ANOLA	56-57	MILTON	58, 86	VOLPINO	45
ARCHA	37	MILTON 1	86	ZIMBA	111
ARIOLLA	29	MINORCA	88	ZIMBA LED	110
ARKTIC	44	MORINO	32-33, 44-45		
ASCOLI	20	MOUNA	28		
BAREDO	87	NADELA	36		
BASALGO	11	NAGO	48, 58		
BASALGO 1	10	NAVEDO	92-95		
BENACO	37	NEMA	104		
BEVERLY	15	NEMA 1	104		
BOSARO	35	NISIA	30		
BREGANZO	46	NISIA 1	31		
BUCKINGHAM	85	NOCELLA	48		
CABOS	21	NORIKA 1	44		
CADIZ 1	14-15	OHIO	30		
CALGARY	25	ONJA	54		
CALGARY 1	24	OUTDOOR CLASSIC	90		
CATONE	68	PANAMA 1	26		
CERNO	53	PARDELA	42		
CERVA	87	PARDELA 1	38		
CITY	50,58	PARK	46		
CITY 1	50	PARK 4	113		
CITY 2	49	PARK 5	47		
CITY CLASSIC	100	PATERNO	74-75		
CITY LED	52	PIAS	38, 43		
CONNECTOR BOX	113	PORTICI	87		
CORFINO	45	PREDAZZO	36		
CORNER MOUNT	112	RAIANO	89		
CUBA	112	RALORA	35		
DARIL	53	RAVARINO	37		
DETECT ME	112	REDONDO	32-33		
ESPARTA	36	RIGA	17-19		
ESPARTA 1	34	RIGA 1	104		
EXIT 1	84	RIGA 2	17		
FAEDO	106-107	RIGA 3	109		
FASTRO	35	RIGA-LED	16		
FASTRO 1	35	ROFFIA	24		
FERROTERRA	66	RUSTEGA	43		
FONTACINA	11	SAN TELMO	89		
FONTELA	42	SEVILLA	49, 58		
HELSINKI	22-23	SHUKO	68		
HELSINKI-LED	22-23	SIDNEY	82-83		
ISOBA	52	SIONES	56		
KALEO	68	SOJO	34		
KIBEA	35	STOCKHOLM 1	21		
KONYA	15	TABO	41		
LAMEDO	109	TABO 1	41		
LATERNA 4	96-97	TABO-LED	38		
LATERNA 5	98-99	TERRALUNA	70		
LATERNA 7	100	TERRENO	66		
LAVORIA	48	TERRICO	62-63		
LEPUS	58	TRONO 1	13		
LISIO	80	TRONO 2	13		
LORENA	64	TRONO STICK	13		

# Legend

ARTICLE NUMBER  
ARTIKELNUMMER  
NUMÉRO D'ARTICLE

SENSOR  
SENSOR  
SENSOR

This symbol indicates luminaires with a sensor. In addition the sensor angle, sensor distance and lighting duration (min./max.) is indicated.

Ist die Leuchte mit einem Sensor ausgestattet, wird dies durch ein Sensorsymbol gekennzeichnet. Zusätzlich werden Ausstrahlungswinkel, Sensorreichweite und Einschaltdauer (max./min.) angegeben.

Un produit avec cette symbole ont un détecteur de mouvement. Aussi le angle d'émission, la portée et la durée sont indiqués.

DESCRIPTION  
BESCHREIBUNG  
DESCRIPTION

The product description is composed as follows: luminaire type; enclosure material, enclosure colour / glass or shade material, glass or shade colour

Die Produktbeschreibung setzt sich wie folgt zusammen: Leuchtenart; Gehäusematerial, Gehäusefarbe / Schirm- bzw. Glasmaterial, Schirm- bzw. Glasfarbe

La description du produit est composée comme suit: type de luminaire; matériel de boîtier, couleur de boîtier / matériel de verre ou abat-jour, couleur de verre ou abat-jour

DIMENSIONS  
DIMENSIONEN  
DIMENSIONS

all dimensions in mm | alle Größen in mm | toutes dimensions en mm

L = length | Länge | longueur  
B = width | Breite | largeur  
H = height | Höhe | hauteur  
Ø = diameter | Durchmesser | diamètre  
A = projection length | Ausladung | amplitude  
ET = installation depth | Einbautiefe | profondeur utile  
Base = base dimensions | Sockelmaße | dimensions de base

Attention! The dimensions relate solely to the sizes of the luminaire. Any air spaces that would be relevant for a safe operating of the lamp were not considered.

Achtung! Die Größen beziehen sich nur auf die Abmessungen der Leuchte. Etwaige Lufträume, die für einen sicheren Betrieb der Leuchte notwendig sind, werden nicht berücksichtigt.

Attention! Les dimensions se réfèrent à la taille de la lampe seulement. Espacements éventuels, que seraient importants pour une opération de la lampe sans danger, n'ont pas été considérés.

PICTOGRAMMES  
PIKTOGRAMME  
PICTOGRAMMES

Technical details are represented as pictogrammes. An overview over all pictograms can be found on the next pages.

Technische Details werden als Piktogramme dargestellt. Eine Übersicht über alle Piktogramme finden Sie auf den nächsten Seiten.

Les détails techniques sont représentés sous forme de pictogrammes. Vous trouverez un aperçu de tous les pictogrammes dans les pages suivantes.

SERIES NAME  
SERIENNAME  
NOM DE LA SÉRIE

CAMERA  
KAMERA  
CAMÉRA

A product with the camera symbol is separately shown in an ambience picture.

Ein Produkt mit dem Kamerasymbol ist separat in einem Ambientebild abgebildet.

Un produit avec le symbole de caméra est représenté séparément dans une image d'ambiance.

BUTTONS  
BUTTONS  
BOUTTONS

LED colour | LED Farbe | couleur de LED



EI bulbs not included | Leuchtmittel exklusive | ampoules non comprise



EI bulbs included | Leuchtmittel inklusive | ampoules comprises

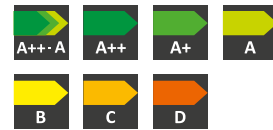

EEL Erklärung | Description | Description p. 120-121

SKETCHES  
SKIZZEN  
CROQUIS

The sketches state the most meaningful dimensions. If a product is adjustable by will, a turquoise arrow marks this function and only the maximum dimensions are indicated.

Die Bemaßung der Skizzen umfasst jeweils die aussagekräftigsten Größen. Bei verstellbaren Produkten kennzeichnet ein türkiser Pfeil diese Funktion und nur die maximalen Größen werden angegeben.

Les dimensions des croquis comprennent les plus représentatives. Si un produit est réglable au choix, une flèche turquoise affiche cette fonction et rien que les dimensions maximales sont indiquées.

SPARE PARTS  
ERSATZTEILE  
PARTS DE REMPLACEMENT

If a product has spare parts they are marked on the photograph with their corresponding article number.

Wenn zu einem Produkt Ersatzteile vorhanden sind, werden diese in der Abbildung mit deren Artikelnummer markiert.

Si un produit a des parts de remplacement, elles sont marquées dans la photo.

30192 CERNO

GL2890

90.0°, 7.0 m  
10 - 240 sec.

wall luminaire; stainless steel, stainless steel / satinated glass, white  
Wandleuchte; Edelstahl, edelstahl / Glas satiniert, weiss applique; acier inoxydable, acier inoxydable / verre satiné, blanc

L 140, H 190, A 110

E27 1x 40W IP44

GL2890

ARTICLE NUMBER  
ARTIKELNUMMER  
NUMÉRO D'ARTICLE

DESCRIPTION  
BESCHREIBUNG  
DESCRIPTION

The product description is composed as follows: luminaire type; enclosure material, enclosure colour / glass or shade material, glass or shade colour

Die Produktbeschreibung setzt sich wie folgt zusammen:  
Leuchtenart; Gehäusematerial, Gehäusefarbe / Schirm- bzw. Glasmaterial, Schirm- bzw. Glasfarbe

La description du produit est composée comme suit: type de luminaire; matériel de boîtier, couleur de boîtier / matériel de verre ou abat-jour, couleur de verre ou abat-jour

DIMENSIONS  
DIMENSIONEN  
DIMENSIONS

all dimensions in mm | alle Größen in mm | toutes dimensions en mm

L = length | Länge | longueur  
B = width | Breite | largeur

H = height | Höhe | hauteur

Ø = diameter | Durchmesser | diamètre

A = projection length | Ausladung | amplitude

ET = installation depth | Einbautiefe | profondeur utile

Base = base dimensions | Sockelmaße | dimensions de base

Attention! The dimensions relate solely to the sizes of the luminaire. Any air spaces that would be relevant for a safe operating of the lamp were not considered.

Achtung! Die Größen beziehen sich nur auf die Abmessungen der Leuchte. Etwaige Lufträume, die für einen sicheren Betrieb der Leuchte notwendig sind, werden nicht berücksichtigt.

Attention! Les dimensions se réfèrent à la taille de la lampe seulement. Espacements éventuels, que seraient importants pour une opération de la lampe sans danger, n'ont pas été considérés.

PICTOGRAMMES  
PIKTOGRAMME  
PICTOGRAMMES

Technical details are represented as pictogrammes. An overview over all pictograms can be found on the next pages.

Technische Details werden als Piktogramme dargestellt. Eine Übersicht über alle Piktogramme finden Sie auf den nächsten Seiten.

Les détails techniques sont représentés sous forme de pictogrammes. Vous trouverez un aperçu de tous les pictogrammes dans les pages suivantes.

SERIES NAME  
SERIENNAME  
NOM DE LA SÉRIE

CAMERA  
KAMERA  
CAMÉRA

A product with the camera symbol is separately shown in an ambience picture.

Ein Produkt mit dem Kamerasymbol ist separat in einem Ambientebild abgebildet.

Un produit avec le symbole de caméra est représenté séparément dans une image d'ambiance.

LED  
LED  
LED

Only high-quality LED illuminants, stripes and boards are used for this luminaire.

Bie dieser Leuchte werden nur hochwertige LED Leuchtmittel, Bänder oder Platinen eingesetzt.

Seulement des ampoules LED, des bandes ou des platines de haute qualité sont utilisés pour ces luminaires.

BUTTONS  
BUTTONS  
BOUTONS

LED colour | LED Farbe | couleur de LED



EEL bulbs not included | Leuchtmittel exklusive | ampoules non comprises



EEL bulbs included | Leuchtmittel inklusive | ampoules comprises

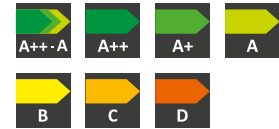

EEL Erklärung | Description | Description p. 120-121

SKETCHES  
SKIZZEN  
CROQUIS

The sketches state the most meaningful dimensions. If a product is adjustable by will, a turquoise arrow marks this function and only the maximum dimensions are indicated.

Die Bemaßung der Skizzen umfasst jeweils die aussagekräftigsten Größen. Bei verstellbaren Produkten kennzeichnet ein türkiser Pfeil diese Funktion und nur die maximalen Größen werden angegeben.

Les dimensions des croquis comprennent les plus représentatives. Si un produit est réglable au choix, une flèche turquoise affiche cette fonction et rien que les dimensions maximales sont indiquées.

93991 BOSARO











wall luminaire; galvanized steel, white  
Wandleuchte; Stahl verzinkt, weiss  
applique; acier galvanisé, blanc

L 170, H 270, A 105



# Legend

## SWITCHES SCHALTER INTERRUPTEURS

-  **internal dimmer**  
eingebauter Dimmer  
variateur intégré
-  **rocker switch**  
Wippschalter  
interrupteur à bascule
-  **pull switch**  
Zugschalter  
interrupteur à tirer
-  **pedal switch**  
Trittschalter  
interrupteur à pied
-  **pedal dimmer**  
Trittdimmer  
variateur à pied
-  **button switch**  
Druckknopf  
interrupteur de pression
-  **cable switch**  
Kabelschalter  
interrupteur à câble
-  **sensor**  
Sensor  
sensor
-  **remote control**  
Fernbedienung  
télécommande
-  **This luminaire can be switched on/off and dimmed by touching the specially designed "Touch Me" part of the fixture.**

Diese Leuchte kann ein- bzw. ausgeschaltet und gedimmt werden, indem man sie an den dafür vorgesehenen „Touch Me“ Bereichen berührt.

*Ce luminaire peut être éteint, allumé et gradué simplement en touchant la partie spécialement conçue pour «Touch Me» du luminaire.*

-  **The different lighting atmospheres can be adjusted with a conventional light switch. By pressing the switch in quick succession the luminaire changes between the different atmospheres (see below), by pressing the switch slowly the luminaire turns on or off. The last setting will then be saved.**

Die unterschiedlichen Lichtstimmungen der Leuchte können mit einem herkömmlichen Lichtschalter bedient werden. Durch schnelles Betätigen des Schalters wechselt die Leuchte zwischen den Einstellungen (siehe unten), langsames Drücken schaltet die Leuchte ein bzw. aus. Dabei wird die letzte Einstellung gespeichert.

*Les ambiances lumineuses de la lampe peuvent être réglées avec un interrupteur conventionnel. Si l'interrupteur est actionné rapidement, la lampe change entre les ambiances différentes (voir ci-dessous); s'il est actionné lentement, la lampe est éteinte ou allumée. La dernière préférence sera mémorisée.*





1x 2x 3x 4x

## PROTECTION CLASS SCHUTZKLASSE CLASSE DE PROTECTION

The protection class indicates to what extent the lamp is protected against electric shock. All lamps in this catalogue are at least protected with the protection class 1 - a higher class is specified in the information box of the respective lamp.

Die Schutzklasse gibt an, inwiefern ein Produkt gegen einen elektrischen Schlag gesichert ist. Alle Leuchten in diesem Katalog sind mit mindestens Schutzklasse 1 gesichert, bei höheren Klassen wird das Symbol im Infokasten der Leuchte angegeben.

*La classe de protection indique, dans quelle mesure la lampe est protégée contre les chocs électriques. Tous les lampes dans ce catalogue sont protégées au moins avec la classe 1 - une classe plus élevée est indiquée dans l'information de la lampe.*

-  **protection class 1: protective earthing**  
Schutzklasse 1: Schutzerdung  
classe de protection 1: prise de terre
-  **protection class 2: protective insulation**  
Schutzklasse 2: Schutzisolierung  
classe de protection 2: double isolation ou renforcée
-  **protection class 3: protective low voltage**  
Schutzklasse 3: Schutzkleinspannung  
classe de protection 3: très basse tension de sécurité

## PROTECTION RATING SCHUTZGRAD INDICE DE PROTECTION

The protection rating ensures the operational safety of luminaires. The first number specifies the extent of the protection against the ingress of foreign bodies; the second number identifies the humidity protection grade. All luminaires in this catalogue are at least protected with the rating IP20 - a higher rating is specified in the information box of the luminaire.

Der Schutzgrad gewährleistet die Betriebssicherheit von Leuchten. Die erste Ziffer des IP Grades beschreibt den Schutzzumfang gegen das Eindringen von Fremdkörpern, die zweite Ziffer informiert über den Grad des Feuchtigkeitsschutzes. Alle Leuchten in diesem Katalog sind mit mindestens Schutzgrad IP20 gesichert, bei höheren Graden wird das Symbol im Infokasten der Leuchte angegeben.

*L'indice de protection assure la sécurité opérationnelle des luminaires. Le premier chiffre indique à quel point la protection est efficace contre l'insertion de corps étrangers; le second chiffre indique quant à lui le degré de protection par rapport à l'humidité. Tous les luminaires dans ce catalogue sont protégés au moins avec l'indice IP20 - un indice plus élevé est indiqué dans l'information d'article.*







-  **IP33**
-  **IP44**
-  **IP54**
-  **IP65**
-  **IP67; IP68**

## LUMINOUS COLOUR / FLUX LICHTFARBE / -STROM COULEUR / FLUX LUMINEUX









The colours of the LED are represented as pictogrammes (see below), their luminous flux directly beneath. The luminous flux is quoted in lumen and describes the amount of light generated by the LED. The higher the value, the brighter is the lamp.

Die Farben der LED werden als Piktogramm (siehe unten) dargestellt, deren Lichtstrom direkt darunter. Der Lichtstrom wird in Lumen gemessen und gibt die erzeugte Lichtmenge der LED an. Je höher der Wert, desto heller das Produkt.

















*Les couleurs de LED ont représentés sous forme de pictogrammes, leur flux lumineux directement en dessous. L'unité de flux lumineux est le lumen et il mesure la quantité de lumière générée par les LED. Plus la valeur est élevée, plus la lampe est lumineuse.*

-  **warm white (< 3300K)**  
warmweiß (< 3300K)  
blanc chaud (< 3300K)
-  **neutral white (3300K - 5300K)**  
neutralweiß (3300K - 5300K)  
blanc neutre (3300K - 5300K)
-  **cold white (> 5300K)**  
kaltweiß (> 5300K)  
blanc froid (> 5300K)
-  **colour changing**  
farbwechselnd  
changeant de couleur
-  **blue**  
blau  
bleu
-  **tunable white**  
tunable white  
tunable white











## FURTHER PICTOGRAMMES WEITERE PICTOGRAMME AUTRES PICTOGRAMMES

-  **replaceable LED**  
austauschbare LED  
LED remplaçables
-  **dimmable**  
dimmbar  
graduable
-  **not dimmable**  
nicht dimmbar  
ne pas graduable
-  **corner mounting possible (accessory p. 112)**  
Eckmontage möglich (Zubehör S. 112)  
montage dans le coin possible (accessoire p. 112)
-  **incl. cable & plug**  
inkl. Kabel & Stecker  
incl. câble & connecteur
-  **maximum allowable load**  
maximal zulässige Belastung  
charge maximale admissible
-  **cutout (in mm)**  
Ausschnitt (in mm)  
perçage du panneau (en mm)
-  **packaging / delivery unit**  
Verpackungs- / Liefereinheit  
unité d'emballage / de livraison











**SOCKETS**  
FASSUNGEN  
DOUILLES

 2GX13	 E14	 E27	 G4	 G5
 G9	 G10Q	 G13	 G23	 GR8
 GU5,3	 GU10	 GX53	 GY6,35	 LED
 R7S				

**LED LAMPS**  
LED LAMPEN  
LAMPES LED

 E14 C35 LED	E14	 E14 G45 LED	E14	 E14 R50 LED	E27	 E27 A60 LED	E27	 E27 G80 LED	G4
 E27 R63 LED	GU5,3	 G4 LED	G4	 MR16 LED	GU5,3	 GU10 LED	GU10	 GX53 LED	GX53
 G9 LED	G9								

**FLUORESCENT LAMPS**  
LEUCHTSTOFFLAMPEN  
LAMPES FLUORESCENTES

 E14 TUBE	E14	 E14 D45 CFL	E14	 E27 TUBE	E27	 E27 G100 CFL	E27	 G23 TUBE	G23
 GR8 BENT	GR8	 T5 TUBE	G5	 T5 RING	2GX13	 T8 TUBE	G13	 T9 RING	G10Q

**HALOGEN LAMPS**  
HALOGENLAMPEN  
LAMPES HALOGENES

 E14 C35 ECO	E14	 E14 D45 ECO	E14	 E27 A55 ECO	E27	 E27 R63 ECO	E27	 G4	G4
 G9	G9	 MR16	GU5,3	 GU10	GU10	 GY6,35	GY6,35	 R7S	R7S

**INCANDESCENT LAMPS**  
ALLGEBRAUCHSLAMPEN  
LAMPES À INCANDESCENCE

 E14 C35	E14	 E14 C35 TIP	E14	 E14 G40	E14	 E27 A60	E27	 E14 R50	E14
 E27 R63	E27								

Energieeffizienz-Label

# Energy efficiency labels

Label de l'efficacité énergétique

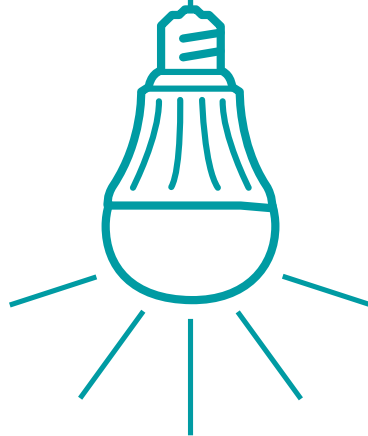
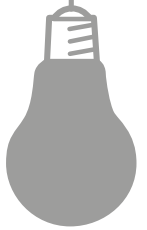
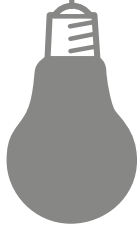

LED luminaires are increasingly popular and the demand for energy-efficient solutions is gaining strength. This has resulted in the adoption of several EU regulations prescribing the energy efficiency labelling of light sources and luminaires. We have prepared a brief overview of the new energy labels.

LED Leuchtmittel sind am Vormarsch, der Ruf nach energieeffizienten Lösungen wird immer größer. In den letzten Jahren wurden daher mehrere EU-Verordnungen verabschiedet, die die Kennzeichnung der Energieeffizienz bei Leuchtmitteln und Leuchten vorschreibt. Hier finden Sie eine kurze Übersicht der neuen Energieeffizienzkennzeichnung.

*Les éclairages LED gagnent du terrain, la demande de solutions efficaces en énergie ne cesse de croître. C'est la raison pour laquelle plusieurs directives européennes prescrivant le marquage de l'efficacité énergétique des moyens d'éclairage et des lampes ont été promulguées au cours de ces dernières années. Vous trouverez ici un bref aperçu d'ensemble des nouveaux marquages de l'efficacité énergétique.*

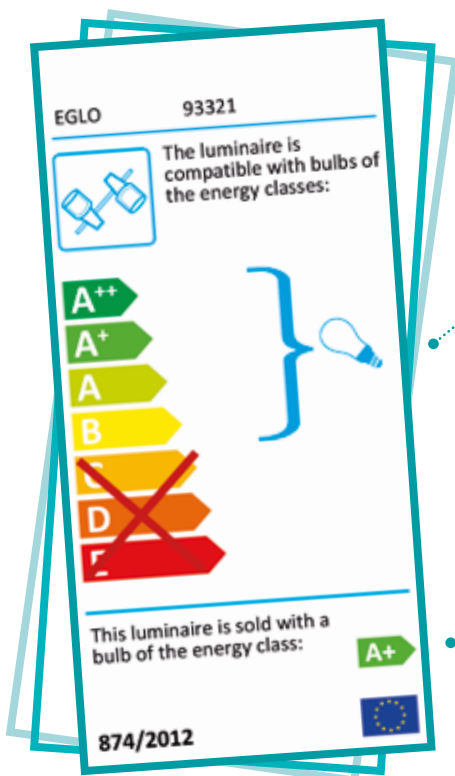

The information in brackets at the centre of the label indicates which bulbs may be used for the luminaire. In this case, the product is only compatible with bulbs with an energy efficiency rating of better than C.

Die Klammer in der Mitte des Labels gibt an, mit welchen Leuchtmitteln die Leuchte kompatibel ist. In diesem Fall dürfen nur Leuchtmittel verwendet werden, deren Energieklasse effizienter als C ist.

*La parenthèse au milieu du label indique les moyens d'éclairage avec lesquels la lampe est compatible. Il est seulement permis dans ce cas d'utiliser des moyens d'éclairage dont la classe d'énergie présente une efficacité supérieure à C.*

If bulbs are included with the luminaire, their energy classes are indicated at the bottom of the label.

Falls Leuchtmittel inkludiert sind, wird deren Energieklasse im unteren Teil des Labels angegeben.

*Si des moyens d'éclairage sont inclus, leur classe énergétique est indiquée dans la partie inférieure du label.*



## EEL BUTTONS

### bulbs included

inkl. Leuchtmittel | *ampoules comprises*



incl. highly efficient LED boards (cannot be replaced by the end consumer)

inkl. hocheffizienter LED Platinen (können nicht vom Endkonsumenten ausgetauscht werden)

*incl. platines LED très efficaces (ne peuvent pas être remplacés par le consommateur final)*



incl. highly efficient LED bulbs

inkl. hocheffizienter LED Leuchtmittel  
*ampoules à LED plus efficaces comprises*



incl. efficient LED and/or fluorescent bulbs

inkl. effizienter LED und/oder Leuchtstoff-Leuchtmittel

*ampoules à LED et/ou fluorescentes efficaces comprises*



incl. halogen bulbs

inkl. Halogen-Leuchtmittel

*ampoules halogènes comprises*

### bulbs not included

exkl. Leuchtmittel | *ampoules non comprises*



The luminaire is compatible with bulbs of all energy classes.

Die Leuchte ist mit Leuchtmitteln aller Energieklassen kompatibel.

*compatible avec des ampoules de toutes les classes de l'énergie*



The luminaire is only compatible with energy efficient bulbs.

Die Leuchte ist nur mit energieeffizienten Leuchtmitteln kompatibel.

*compatible uniquement avec des ampoules économes en énergie*

This label indicates that no bulbs are included with the luminaire. Consumers are free to choose their preferred bulb within the indicated energy classes.

Dieses Label wird verwendet, wenn die Leuchte ohne Leuchtmittel ausgeliefert wird. Der Kunde kann selber entscheiden, welches Leuchtmittel der angegebenen Klassen verwendet wird.

*Ce label est utilisé lorsque la lampe est livrée sans ampoules. Le client peut décider lui-même quel ampoule des classes indiquées est utilisé.*

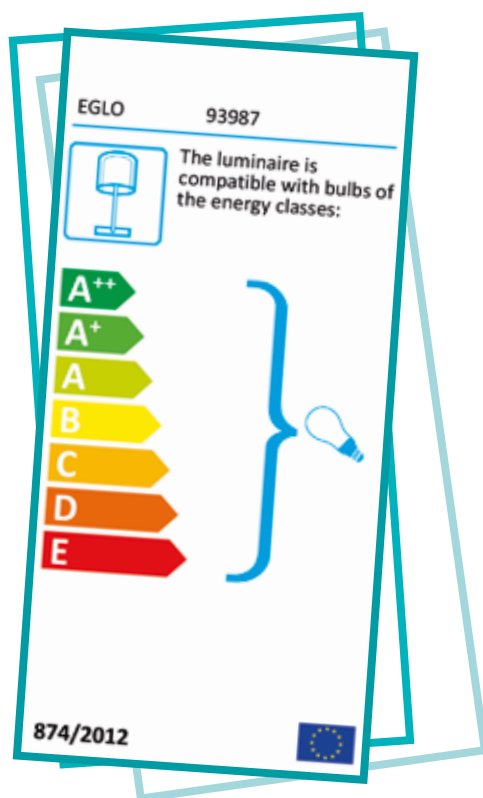

This label indicates that the luminaire is sold with built-in LED lamps that cannot be replaced by the consumer himself.

Dieses Label wird verwendet, wenn Leuchten mit LED-Modulen verkauft werden, die vom Endkunden nicht selbstständig ausgetauscht werden können.

*Ce label est utilisé lorsque des lampes sont vendues avec des modules LED ne pouvant pas être changés par les clients finaux eux-mêmes.*

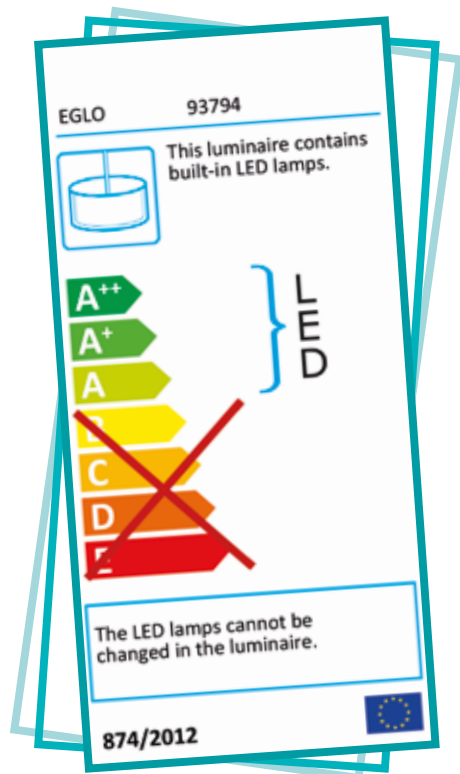

**HEADQUARTERS**

EGLO LEUCHTEN GMBH  
Heiligkreuz 22  
A-6136 PILL  
T: +43 5242 6996 0 | F: +43 5242 6996 938  
E: info-austria@eglo.com

**AUSTRALIA**

EGLO LIGHTING AUSTRALIA PTY.LTD.  
1026 South Road  
EDWARDSTOWN S.A. 5039  
T: +61 8 82 77 11 66 | F: +61 8 82 77 19 66  
E: info-australia@eglo.com

**BELGIUM**

EGLO BELGIUM B.V.B.A.  
Westpoort 25 | 4906 AA OOSTERHOUT  
Visit Address: Innovatiepark 20 | 4906 AA OOSTERHOUT (NL)  
T: +32 3 250 60 80 | F: +32 3 219 80 67  
E: info-belgium@eglo.com

**BOSNIA-HERZEGOVINA**

EGLO RASVJETA BH D.O.O.  
Ormanica bb  
BIH-76250 GRADACAC  
T: +387 35 86 85 00 | F: +387 35 82 44 41  
E: eglo@bih.net.ba

**BRAZIL**

EGLO DO BRASIL LUMINÁRIAS LTDA.  
Avenida Tamboré | 1180 - Armazém A-10  
BARUERI - SP 06460-000  
T: +55 11 4193 6980 | F: +55 11 4193 6981  
E: info-brazil@eglo.com

**BULGARIA**

EGLO BULGARIA EOOD  
2B 'Serdika' Str.  
8000 BOURGAS  
T: +359 56 960 403 | F: +359 56 53 05 95  
E: info-bulgaria@eglo.com

**CANADA**

EGLO CANADA INC.  
20700 Route Transcanadienne  
Baie D'Urfé, Québec | H9X 4B7  
T: +1 514 457 5483 | F: +1 514 457 5487  
E: info-canada@eglo.com

**CHILE - IQUIQUE**

EGLO CHILE ILUMINACION LTDA.  
Manzana 10 | Galpón 5 | Recinto  
Amurallado | Zona Franca Iquique - CHILE  
T: +56 57 2 4174 72 | F: +56 57 2 4174 69  
E: info-chile@eglo.com

**CHILE - SANTIAGO**

EGLO CHILE ILUMINACION LTDA.  
Av. Américo Vespucio 1930  
Conchali - SANTIAGO DE CHILE  
T: +56 2 595 2222  
E: info-chile@eglo.com

**CHINA**

DONGGUAN EGLO LIGHTING COMMERCIAL CO LTD  
No.1 | Shangqiao Industrial Road | Shangqiao, Dongcheng District  
DONGGUAN CITY, GUANZHOU PROVINCE | CHINA  
T: +86 769 2203 3866 | F: +86 769 2203 6866  
E: info-china@eglo.com

**CROATIA**

EGLO RASVJETA D.O.O.  
Josipa Loncara 3  
HR-10000 ZAGREB  
T: +385 1 379 40 62 | F: +385 1 379 41 04  
E: info-croatia@eglo.com

**CZECH REPUBLIC**

EGLO CESKO-MORAVSKÁ SVÍTIDLA, SPOL. S.R.O.  
Náchodská 2479/63  
CZ-193 00 PRAHA 9 Horní Pocernice  
T: +420 281 924 163 | F: +420 281 925 205  
E: info-czechrepublic@eglo.com

**DENMARK**

EGLO DANMARK A/S  
Agerbakken 20  
DK-8362 Hørring  
T: +45 70 22 55 11 | F: +45 70 22 55 21  
E: info-denmark@eglo.com

**ESTONIA**

MOODNE VALGUSTUS AS  
Rävala pst. 7  
EE-10143 TALLINN  
T: +372 667 6670 | F: +372 631 3195  
E: info-estonia@eglo.com

**FINLAND**

EGLO FINLAND OY  
Malminraititi 17A  
00700 Helsinki  
T: +358 20 7649 820 | F: +358 20 7649 821  
E: info-finland@eglo.com

**FRANCE**

EGLO FRANCE LUMINAIRE SARL  
Z.A. Jeune Bois | 2 Rue de la Martinique  
F-68274 WITTENHEIM  
T: +33 389 6250 30 | F: +33 389 6250 49  
E: info-france@eglo.com

**GERMANY**

EGLO LEUCHTEN HANDELS GMBH  
Kleinbahnstr. 35  
D-59759 ARNSBERG  
T: +49 2932 6269 0 | F: +49 2932 6269 39  
E: info-germany@eglo.com

**GREECE**

EGLO HELLAS AE  
Leoforos Parnithos 274  
ACHARNAI 136 75  
T: +30 210 240 77 10 | F: +30 210 240 07 29  
E: info-greece@eglo.com

**GREAT BRITAIN**

EGLO UK LTD.  
Unit 12 Cirrus Park, Lower Farm Road, Moulton Park  
Industrial Estate, NORTHAMPTON NN3 6UR  
T: +44 1604 790 986 | F: +44 1604 670 282  
E: info-greatbritain@eglo.com

**MAGYARORSZÁG – ÉRTÉKESÍTÉS**

EGLO LUX KFT.  
FŐ-ÚT 143/A  
H-2120 DUNAKESZI  
T: +36 27 341 353 | F: +36 27 341 409  
E: info-hungary@eglo.com

**HUNGARY - PRODUCTION & LOGISTICS**

EGLO MAGYARORSZAG KFT.  
FŐ-ÚT. 155  
H-3060 PASZTO  
T: + 36 32 560 050 | F: +36 32 560 040  
E: info-hungary@eglo.com

**INDIA**

EGLO INDIA PRIVATE LIMITED  
A-304, Ansal Chamber I, 3 Bhikaji Cama Place,  
Delhi-110066  
T: +91 981 108 2205  
E: info-india@eglo.com

**ITALY**

EGLO ITALIANA S.R.L.  
Via Giotto N. 4  
I-31021 MOGLIANO VENETO (TV)  
T: +39 041 456 6245/251 | F: +39 041 457 4066  
E: info-italy@eglo.com

**JAPAN**

EGLO JAPAN K.K.  
4-14-14 Nishiazabu | Minatoku  
TOKYO 106-0031  
JAPAN  
E: info-japan@eglo.com

**KAZAKHSTAN**

EGLO KAZAKHSTAN LLP  
Office 300, Floor 24, Block 5A, Nurly-Tau Business Centr,  
Al-Farabi Avenue 7, 050059, Almaty Kazakhstan  
T: +7 727 293 25 20 | M: +7 701 727 6000  
E: info-kazakhstan@eglo.com

**KOSOVO**

EGLO KOSOVA LLC  
Lugisht e qytetit pn  
20000 PRIZREN- KOSOVO  
T: +377 44 2166 87 | Shop: +381 29 2442 84  
E: info-kosovo@eglo.com

**MALAYSIA**

EGLO ASIA SDN BHD  
1.07, level 1, Wisma Academy, Lot 4A, Jalan 19/1, 46300 Petaling  
Jaya. Selangor Darul Ehsan, Malaysia  
T: +603 7956 5277 | F: +603 7931 6277  
E: info-malaysia@eglo.com

**MEXICO**

EGLO MÉXICO ILUMINACIÓN S DE RL DE CV  
Prolongación Av. López Mateos Sur N°3561, Fracc. Los Gavilanes.  
C.P. 45645, Tlajomulco de Zúñiga, Jalisco. México  
T: +52 33 3687 20 95  
E: info-mexico@eglo.com

**MIDDLE EAST**

EGLO LIGHTING MIDDLE EAST FZE  
P.O. BOX 262073, LOB 6, OFFICE G18  
JEBEL ALI, DUBAI, UAE  
T: +97 148810080 | F: +97 148810081  
E: info-middle-east@eglo.com

**MOROCCO**

EGLO MAGHREB LUMINAIRE SARL  
Zone Industrielle, Lots n° 6 et 7  
26000 SETTAT / MAROC  
T: +212 523 721 013 | F: +212 523 721 028  
E: info-maghreb@eglo.com

**THE NETHERLANDS**

EGLO VERLICHTING NEDERLAND B.V.  
Innovatiepark 20  
4906 AA OOSTERHOUT (NBR)  
T: +31 162 48 28 30 | F: +31 162 48 28 40  
E: info-nl@eglo.com

**NORWAY**

ELEKTRO-ARMATUR a.s  
Bjørnerudveien 18  
N-1266 OSLO  
T: +47 2262 9000 | F: +47 2262 9040  
E: post@ea.no

**PERU**

EGLO PERU S.A.C  
Avda. Santa Cruz No. 458  
San Isidro - Lima  
T: +51 1 4212 158  
E: info-peru@eglo.com

 **POLAND**  
EGLO POLSKA SP. Z.O.O.  
Ul. Pulawska 479  
02-844 WARSZAWA  
T: +48 22 644 57 55 | F: +48 22 644 89 82  
E: info-poland@eglo.com

 **PORTUGAL**  
EGLO PORTUGAL ILUMINACAO, LDA  
Rua Fonte Parada, 125  
PT-4595-434 SEROA-PAÇOS DE FERREIRA  
T: +351 255 890 000 | F: +351 255 892 346  
E: info-portugal@eglo.com

 **RUSSIA**  
EGLO LIGHTING LLC  
Varshavskoe shosse 35 | Building 1  
RU-117105 | MOSCOW  
T: +7495 789 4311 | F: +7495 789 4312  
E: info-russia@eglo.com

 **ROMANIA**  
EGLO ROMANIA PRODEXIM SRL.  
Str. Atomistilor nr. 1D  
R-077125 MAGURELE - ILFOV - ROMANIA  
T: +40 314 250 902 | F: +40 314 250 899  
E: info-romania@eglo.com

 **SERBIA**  
EGLO RASVETA DOO  
Stefana Prvovenčanog 28  
11000 BEOGRAD | SRBIJA  
T: +381 11 3981 366 | F: +381 11 3981 389  
E: info-serbia@eglo.com

 **SLOVAKIA**  
EGLO CESKO-MORAVSKÁ SVÍTIDLA, SPOL. S.R.O.  
Náchodská 2479/63  
CZ-193 00 PRAHA 9 Horní Pocernice  
T: +421 313 211 551 | F: +421 313 211 556  
E: info-slovakia@eglo.com

 **SLOVENIA**  
EGLO RASVJETA D.O.O.  
Josipa Loncara 3  
HR-10000 ZAGREB  
T: +386 158 093 18 | F: +386 158 093 27  
E: info-slovenia@eglo.com

 **SPAIN**  
EGLO ESPANA ILUMINACION S.L.  
Avda. de Castilla 1 (Edf. Best Point) 2º-16A  
San Fernando de Henares, E-28830 MADRID  
T: +34 91 677 9044 | F: +34 91 677 0304  
E: info-spain@eglo.com

 **SWEDEN**  
EGLO SVERIGE AB  
Honungsgatan 3  
S-432 95 VARBERG  
T: +46 340 623 505 | F: +46 340 623 605  
E: info-sweden@eglo.com

 **SWITZERLAND**  
EGLO SCHWEIZ AG  
Seetalstraße 142  
CH-6032 EMMEN  
T: +41 41 268 69 59 | F: +41 41 268 69 58  
E: info-switzerland@eglo.com

 **TURKEY**  
Eglo Aydınlatma ithalat ihracat Ltd. Şti.  
Eyüp Sultan Mah. Sekmen Cad. No:18/1  
34855 SAMANDIRA, SANCaktepe / ISTANBUL  
T: +90 216 311 09 -02 / -03 / -04 | F: +90 216 311 09 -05  
E: info-turkey@eglo.com

 **UKRAINE**  
EGLO UKRAINE LTD  
Str. Marka Vovchka 14  
UA-04073 KIEV  
T: +38 044 463 98 41 | F: +38 044 468 84 67  
E: info-ukraine@eglo.com

 **USA**  
EGLO USA, INC.  
3640 Royal South Parkway  
ATLANTA, GEORGIA 30349  
T: +1 404 477 5601 | F: +1 404 393 7053  
E: info-usa@eglo.com





# Online Catalogues

All our catalogues and folders are also available on computers and mobile devices now. Just use the link or QR-Code below to browse through our assortment. Discover the advantages: easy handling, quick search and find, social media connection, and much more ...

Alle unsere Kataloge und Folder können Sie jetzt auch bequem auf Ihrem Computer und Mobilgeräten ansehen. Einfach Links oder QR-Codes unten benützen und online durchblättern. Erleben Sie die Vorteile: einfache Handhabung, schnelles Suchen und Finden, Social Media Anbindung und vieles mehr ...

Tous nos catalogues et dépliants sont également disponibles en ligne. Il vous suffit d'utiliser le lien ou le QR-code ci dessous pour naviguer à travers nos assortiments. Découvrez les avantages : facile d'utilisation, recherche rapide, connections aux réseaux sociaux, et bien plus encore ....



[www.eglo.com](http://www.eglo.com)



[www.eglo.com/interior](http://www.eglo.com/interior)

Interior Lighting  
Wohnraumleuchten  
*Luminaires Intérieurs*



[www.eglo.com/outdoor](http://www.eglo.com/outdoor)

Outdoor Lighting  
Außenleuchten  
*Luminaires Extérieurs*



[www.eglo.com/solar](http://www.eglo.com/solar)

Solar Lighting  
Solarleuchten  
*Luminaires Solaire*



[www.eglo.com/illuminants](http://www.eglo.com/illuminants)

Illuminants  
Leuchtmittel  
*Lampes*

# Social Media

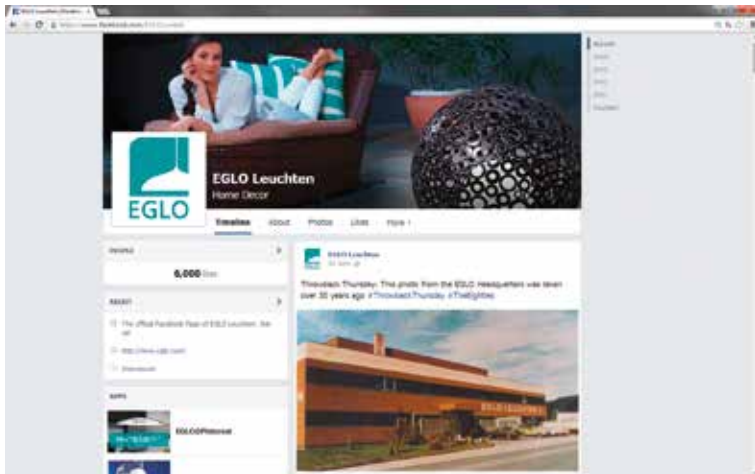

LIKE US!

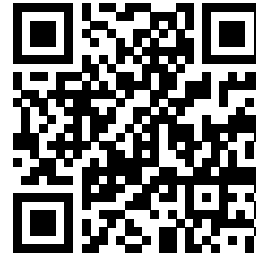

PIN US!

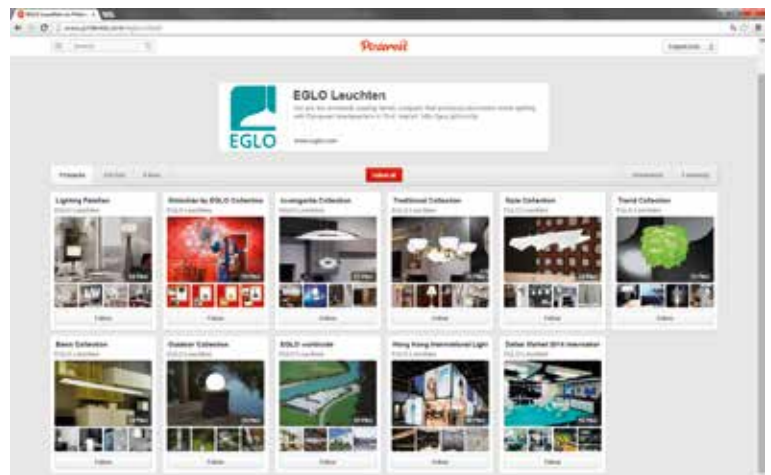
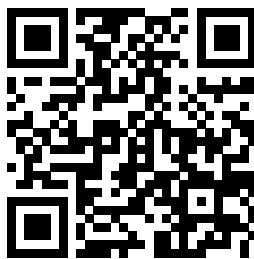

WATCH US!

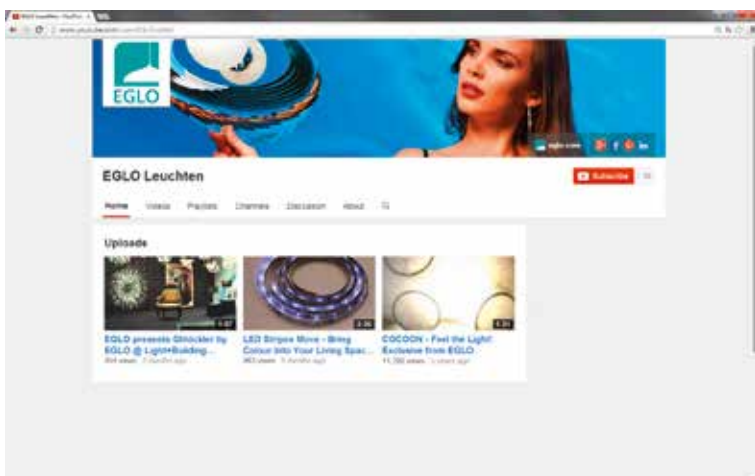
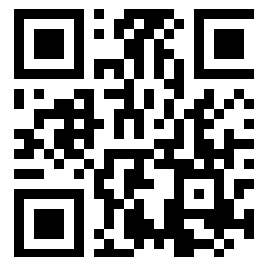





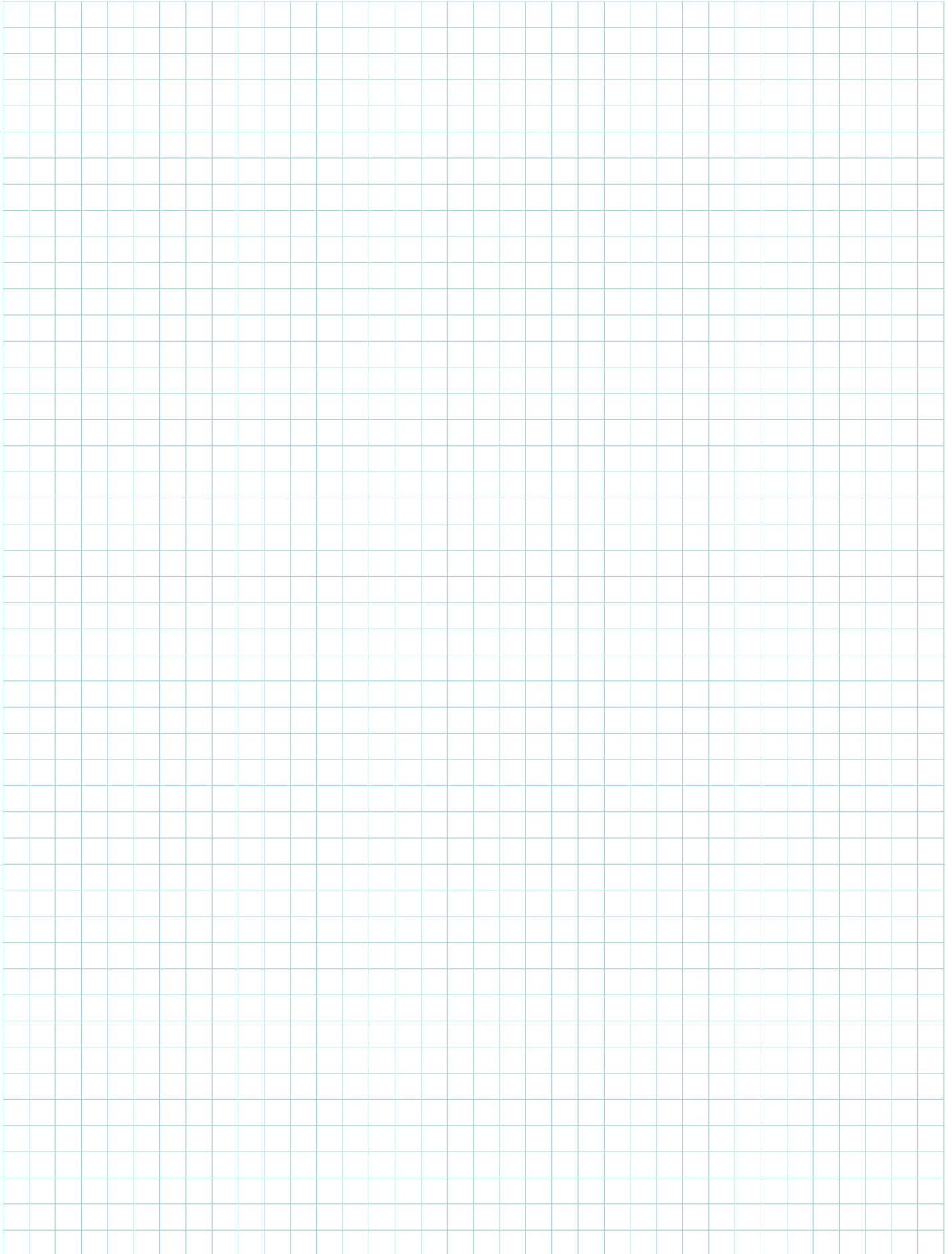



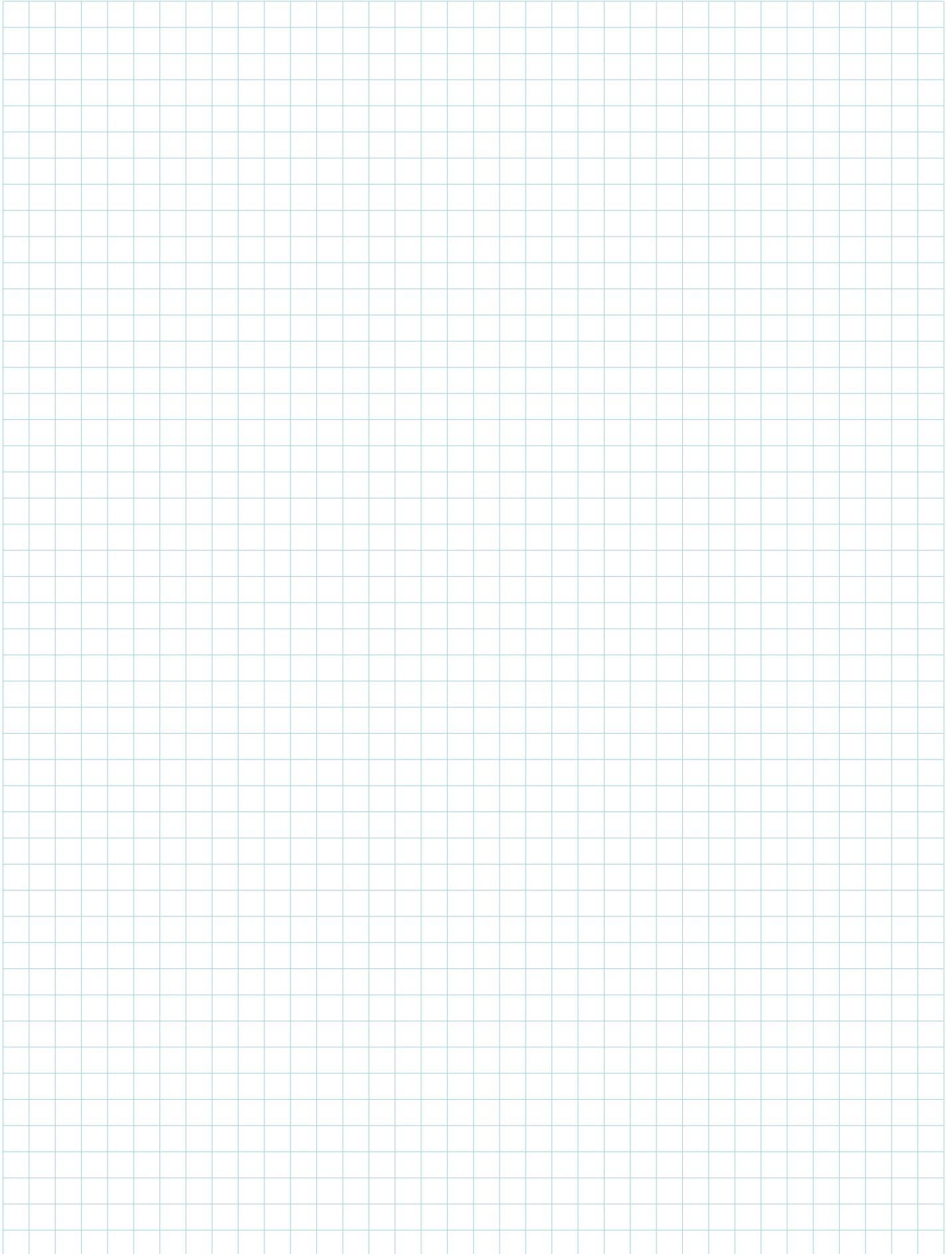



All previous catalogues and price lists are no longer valid with the issue of this catalogue. Errors, misprints, model and price changes and technical modifications are reserved. We deliver based on our terms of delivery and payment. Our products comply with the European light norm EN60598. Products with the ENEC test mark are conforming to the guide line 2006/95/EG. Products with additional safety remarks (e.g protection class, IP) are identified within the product family with the relevant symbol and number. The content of this catalogue is protected under copyright law for EGLO Leuchten GmbH. All rights reserved. Our specific written consent must be obtained before using any illustrations and texts. The pictures are 4C prints and may differ from the original.

The product pictures and ambiances in this catalogue can deviate from reality, and they do not necessarily concur with the usual application of the product. EGLO does not assume liability for the correctness, completeness or the application depiction of the products and/or the product information.

Design, layout and composition: EGLO GmbH, A-6136 Pill - AUSTRIA

Print: Ueberreuter Print GmbH, A-2102 Korneuburg

Pictures: EGLO, thinkstock.com

Mit diesem Katalog verlieren alle vorhergehenden Kataloge und Preislisten ihre Gültigkeit. Irrtümer, Druckfehler, Modell- und Preisänderungen sowie technische Änderungen vorbehalten. Wir liefern zu unseren Liefer- und Zahlungsbedingungen. Unsere Produkte entsprechen der europäischen Leuchtnorm EN 60598. Produkte mit dem ENEC Prüfzeichen sind konform mit der Richtlinie 2006/95/EG. Produkte mit weiteren Sicherheitshinweisen (zB. Schutzklasse, IP) sind mit Symbol und Zahl bei der Produktfamilie ausgezeichnet. Der Inhalt dieses Kataloges ist für die EGLO Leuchten GmbH urheberrechtlich geschützt. Alle Rechte sind vorbehalten. Bilder und Texte dürfen nicht ohne vorherige ausdrückliche, schriftliche Genehmigung verwendet werden. Die Abbildungen sind 4C Drucke und können vom Original abweichen.

Die Katalogbilder und die gezeigten Darstellungen der Produkte können von der Wirklichkeit abweichen und nicht den üblichen Produktanwendungen entsprechen. EGLO übernimmt keine Haftung für die Richtigkeit, Vollständigkeit und Anwendungsdarstellung der Produkte und Produktinformationen.

Gestaltung, Layout und Satz: EGLO GmbH, A-6136 Pill - AUSTRIA

Druck: Ueberreuter Print GmbH, A-2102 Korneuburg

Bilder: EGLO, thinkstock.com

*Le présent catalogue remplace tous les catalogues et tarifs précédents. Sous réserve d'erreurs, de fautes d'impression, de modification des modèles et de changement de prix et de technique. Nous livrons sur la base de nos conditions de livraison et de paiement. Nos produits sont conformes aux normes européennes EN 60598 et portent le marquage CE. Les produits portant la marque ENEC sont conformes à la Directive 2006/95/EG. Les produits portant d'autres indications de sécurité (par exemple classe de protection, IP) sont identifiés par le symbole et le nombre correspondants dans la famille de produits.*

*Le contenu du présent catalogue est protégé pour la société EGLO Leuchten GmbH par un copyright. Tous droits réservés. Toute reproduction d'images et du texte est interdite sans autorisation explicite par écrit préalable. Les images sont imprimées en 4C et peuvent différer de l'original.*

*Les images des produits et les ambiances dans le catalogue peuvent dévier de la réalité et ne sont pas nécessairement en ligne avec l'usage habituel du produit. EGLO n'engage pas sa responsabilité sur la justesse des images et sur les informations relatives à l'usage pouvant être fait des produits.*

*Conception, maquette et composition: EGLO GmbH, A-6136 Pill - AUSTRIA*

*Presse: Ueberreuter Print GmbH, A-2102 Korneuburg*

*Images: EGLO, thinkstock.com*

12-2014





EGLO Leuchten GmbH  
Heiligkreuz 22  
A-6136 Pill  
Austria  
Tel. +43 (0) 5242 6996  
Fax +43 (0) 5242 6996-938  
info@eglo.com  
www.eglo.com

KATA15

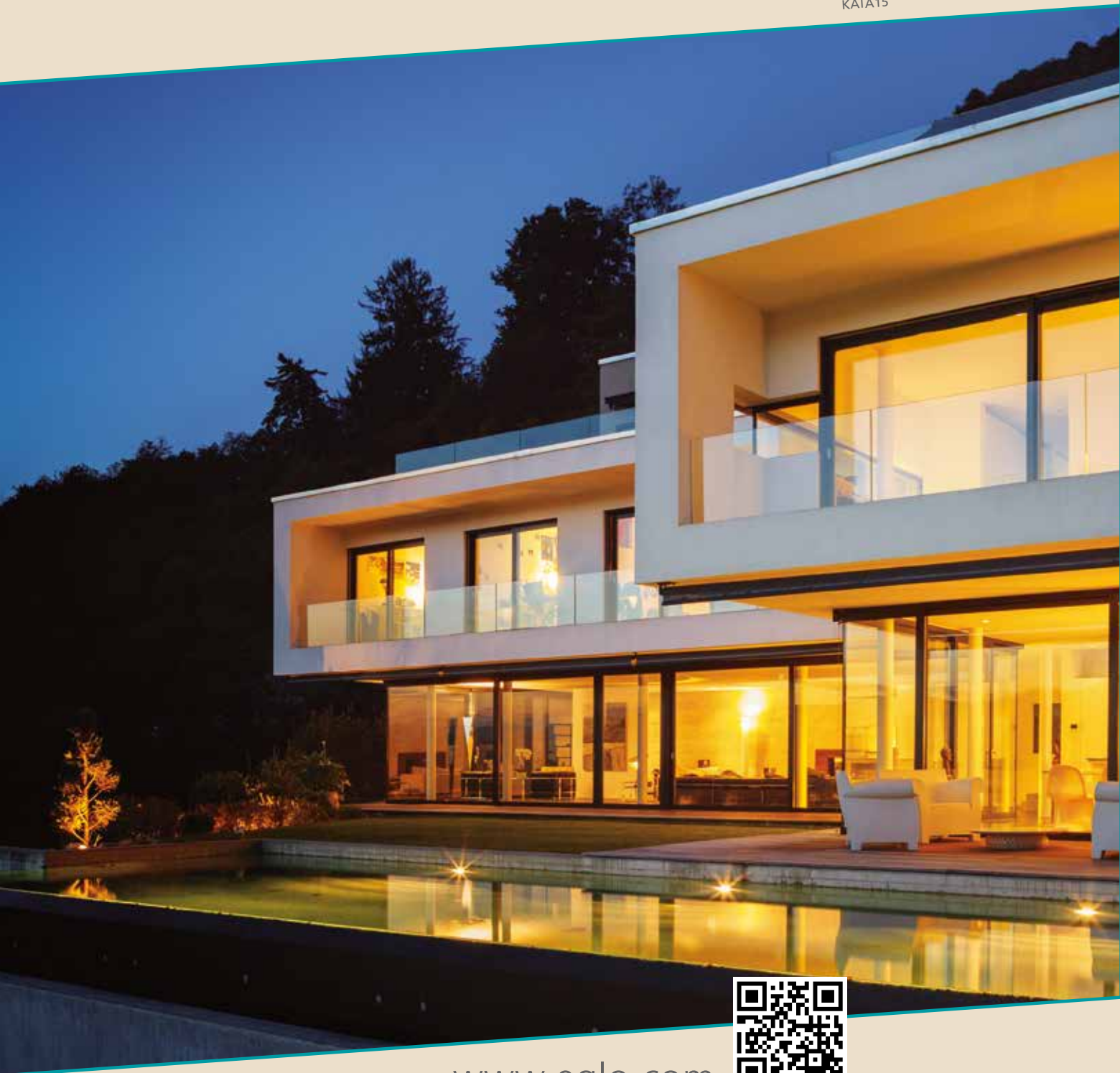

[www.eglo.com](http://www.eglo.com)

